

**EDI-Recommendations
of GS1 Germany
Version 9.3
Media Book**

**Purchase Order
(ORDERS)**

EANCOM 2002 Syntax 3

Introduction.....	2
Business Terms	10
Branching Diagram	13
Message Structure.....	20
Segmentlayout.....	22
Codes	73
Example	147

Einführung

Introduction

The aim of the brochure on hand is to offer documentation describing the exchange of delivery data between business partners.

The basis of this elaboration is the international standard EANCOM® 2002. The message type ORDERS 011 is used to transmit relevant data. GEFEG.FX (Gefeg mbH, Berlin) was used as the documentation tool.

Please be aware to know that this booklet does not replace the complete specifications in the original chapters or other relevant instructions within the EANCOM® 2002 documentation. Instead, it deals with the description of segments, data elements and codes to be used for a specific task.

The current documentation has been produced by the GS1 Germany GmbH in Cologne. GS1 Germany assumes no liability for any damages incurring from the use of this documentation. This brochure or extracts thereof may only be published or forwarded to third parties with the express written consent of GS1 Germany, which holds copyright on this work.

Important note

To fulfill the requirements of directive 2003/58/EG, article 4, C058 has been opened in NAD segments identifying a message sender. If the place in the 5 DE 3124 is not sufficient, the following RFF segments can be used, qualified with DE 1153 = GN. DE 1154 has got a capacity of 70 digits. Only in those cases, when no RFF segment follows NAD, a RFF+GN can be used in the heading section of the message. Within the EDI recommendations of GS! Germany this is only applicable for the messages REMADV and SLSFCT.

This brochure offers different ways to start

Introduction

"Introduction" contains a short description of the respective message.

BusinessTerms

"Business Terms", is a table which links directly to the sequence numbers of the segments.

Diagram

"Diagram", is a hierarchical graphic depiction of all used segments in the same sequence as they are defined in the EANCOM® message. However, every segment is shown only once, and it is therefore possible that the sequence numbering is interrupted.

Structure

"Structure", is a list of all used segments in the same sequence as they are defined in the EANCOM® message. In general, for each piece of information one single segment is provided. Exeptions may arrise when the the occurence of a segment is limited and can contain alternative information (e.g., segment BGM).

Segmentlayout

"Segmentlayout", an illustration that has been chosen to match the business terms (data from the inhouse application) with the elements from the EANCOM® syntax.

Codes

"Codes" contains a list of the codes used in the message.

Einführung

Examples

"Examples", provides at least one message example with comments. Please note that, for technical reasons, the examples can contain component data element separators, which would otherwise be represented as data element separators in the original messages.

Print

"Print" opens the PDF documentation for the corresponding message.

Message structure

Heading section

Specification of buyer and supplier, message date and number.

Detail section

Specification of GTIN to identify goods and services, and quantity.

Summary section

Specification of totals of the message.

REFERENCES IN THE BEVERAGE SECTOR

Note: Orders in the Beverage Industry

The message specifies details for goods or services ordered under conditions agreed between the seller and the buyer.

The ORDERS message applies for the following cases:

- Ordering of full trading units for delivery or self pick up
- Ordering of empties for delivery or self pick up

Examples:

- Ordering of empty crates in case of a surplus of bottles in retail
- Manufacturer orders specific empties from a beverage wholesaler or retailer to relieve a shortage of empties at seasonal peak periods
- Order/ instruction for pickup of empties, e.g. if retail stock of empties has reached peak capacity

Principles

The receiver of goods determines the product identification, quantity, delivery date/time and delivery location within the order. Supplementary information regarding empties can also be indicated.

Trading partners and locations are identified by their Global Location Numbers (GLN). One order is

Einführung

issued for one delivery to one location at one date/time. Traded units are identified only by Global

Einführung

Trade Item Numbers (GTIN). The ordered quantity refers to this traded unit. Each line item refers only to one product.

Additional detailed information can be found in chapter "6. ECR in der Getränkewirtschaft" of the ECR-Supply Side manual.

REFERENCES IN THE MEDIA SECTOR

Supply of goods

The following references are used within the Media sectors to manage the supply of goods:

Einführung

		ORDERS		ORDRSP		DESADV		INVOIC
H e a d i n g S e c t i o n	Order number	BGM DE 1004	⇒	RFF ON	⇒	RFF ON	⇒	RFF ON
	Order number (supplier)	BGM DE 1004	⇒	RFF VN	⇒	RFF VN	⇒	RFF VN
	Customer refer- ence number	RFF CR	⇒	RFF CR	⇒	RFF CR	⇒	RFF CR
	Sellers refer- ence number	RFF SS	⇒	RFF SS	⇒	RFF SS	⇒	RFF SS
	Promotional Deal number	RFF PD	⇒	RFF PD	⇒	RFF PD	⇒	RFF PD
	Purchase order response no.			BGM DE 1004	⇒	RFF POR	⇒	RFF POR
	Despatch advice number					BGM DE 1004	⇒	RFF AAK
	Delivery note number					RFF DQ	⇒	RFF DQ
Sales depart- ment number				⇒	RFF SD	⇒	RFF SD	
D e t a i l S e c t i o n	Sales depart- ment number	RFF SD		RFF SD	⇒	RFF SD	⇒	RFF SD
	Sellers refer- ence number	RFF SS	⇒	RFF SS	⇒	RFF SS	⇒	RFF SS
	Customer refer- ence number	RFF CR	⇒	RFF CR	⇒	RFF CR	⇒	RFF CR
	Delivery note number					RFF DQ	⇒	RFF DQ
	Promotional Deal number	RFF PD	⇒	RFF PD	⇒	RFF PD	⇒	RFF PD

BGM segments are mandatory. RFF-Segments printed in bold are depending. They must be specified in the detail section as far as a default is not defined in the heading section.

In general the customer reference number (RFF+CR) is depending. If the order is generated by the supplier (agent order, VMI) this reference is replaced by the sellers reference number (RFF+SS). Only one reference number is indicated, either the customer reference number or the sellers reference number.

Einführung

Appendix: Codelist "Media"

To be used used in conjunction with DE 3035 = 246 and DE 1131 = MEDIA.

Lable information (ORDERS), FTX:

AF = Box number
 BF = User defined freetext
 BI = Barcode information
 EA = Lable type
 HA = Handling information
 NE = Customer name
 PT = Price text
 RN = Number of storage rack

Order qualifier (ORDERS, ORDRSP, DESADV), FTX:

	ORDERS	ORDRSP	DESADV
DUN = do not record dues (supply only if immediately available)	x	x	x
DUY = record dues (backorder if not immediately available)	x	x	x
ZRN = central settlement, no	x		
ZRY = central settlement, yes	x		
OWN = do not forward order to publisher	x		
OWY = forward order to publisher	x		
RWN = remittance, no	x		
RWY = remittance, yes	x		
ACN = consignment order, no	x		
ACY = consignment order, yes	x		
PKN = backorder, no (until agreed order volume is reached)	x	x	
PKY = backorder, yes (until agreed order volume is reached)	x	x	
TUN = do not supply replacement article	x	x	
TUY = automatic supply replacement article	x	x	
PWN = batch bonus, no	x		
PWY = batch bonus, yes	x		
FSN = order not forwarded to publisher		x	
FSY = order forwarded to publisher		x	

Reasons for return (RETANN, RETINS), CDI:

AC = Over-shipped
 AG = Delivered too late
 ALP = Change of fixed retail price
 AT = Item not ordered
 DME = Damaged
 FLG = Wrong delivery
 VEV = according contract
 X39 = Goods technical failings (inclusive misprints)

Einführung

Instruction for returns (RETINS), CDI:
TBZ = Send back title page

Appendix | Standard Clothes Hanger Return System (SKRS)

If textiles are to be ordered in conjunction with standard hangers, the required hanger type numbers can be found on the following pages. (Cf. SG 34 in the segment layout).

Einführung

Standard-Kleiderbügel-Rückführ-System (SKRS) (Stand: 04.05.2004)						
Vorab-Typnummer	Kurzbezeichnung	Bezeichnung	Farbe	Breiten	Bereich	Einsatzmöglichkeiten
40 23330 99001 4	F 1	Mantelbügel	glasklar	42, 45, 50	Stationärer Handel	Sakkos, Mäntel
40 23330 99002 1	S 1	Steg für den Mantelbügel	glasklar		Stationärer Handel	
40 23330 99003 8	F 1/S 1 montiert	Anzugbügel	glasklar	42, 45, 50	Stationärer Handel	Mäntel, Anzüge
40 23330 99004 5	F 2	Jackenbügel	glasklar	32, 38, 44, 49	Stationärer Handel	Kostüme, Sakkos
40 23330 99005 2	FS 3	Universalbügel	glasklar	40, 45	Stationärer Handel	Universal für HAKA, DOB, Sport
40 23330 99006 9	FO 1	Blusenbügel	glasklar	26, 33, 38, 43, 47	Stationärer Handel	Blusen, Nachtwäsche
40 23330 99007 8	F 3	Jackenbügel	schwarz	38, 44, 49	Versandhandel	Kostüme, Sakkos
40 23330 99008 3	S	Steg für Versandhandelsbügel	schwarz		Versandhandel	
40 23330 99009 0	F 3 / S montiert	Jackenbügel (mit Steg)	schwarz	38, 44, 49	Versandhandel	Mäntel, Anzüge
40 23330 99010 8	F 4	Mantelbügel	schwarz	45, 49	Versandhandel	breitgeschnittene Bekleidung
40 23330 99011 3	S 4	Steg für Versandhandelsbügel	schwarz		Versandhandel	Kommt nicht mehr zum Einsatz
40 23330 99012 0	F 4 / S montiert	Mantelbügel (mit Steg)	schwarz	45, 49	Versandhandel	schwere Bekleidung
40 23330 99013 7	FL 2	Rockbügel	schwarz	46	Versandhandel	Röcke, Hosen
40 23330 99014 4	FO 3	Blusenbügel	schwarz	38, 44	Versandhandel	Blusen, Kleider, Kostüme
40 23330 99015 1	HO 2	Hosenbügel	schwarz	41	Versandhandel	Hosen (kurzhängend)
40 23330 99016 8	HO 1	Hosenbügel (offen)	glasklar	38	Stationärer Handel	Hosen (kurzhängend)
40 23330 99017 5	KL 1	Clipbügel	glasklar	22-28, 36-40	Stationärer Handel	Röcke, Hosen
40 23330 99018 2	SP 1	Spannbügel	glasklar		Stationärer Handel	Einsatz zurückgestellt
40 23330 99019 9	F 5	Universalbügel	schwarz	45	Versandhandel	Universal für DOB
40 23330 99020 5	F 5 / S montiert	Universalbügel (mit Steg)	schwarz	45	Versandhandel	Universal für DOB, HAKA
40 23330 99021 2	HO 3	Hosenbügel (geschlossen)	glasklar	41	Stationärer Handel	Hosen (kurzhängend)
40 23330 99022 9	A1	Adapter für Mantelbügel F 1	schwarz		Stationärer Handel	Verlängerung des F1-45 auf 50er Breite
40 23330 99023 6	KB 1	KIKO-Bügel	glasklar	26, 33, 38, 43	Stationärer Handel	Universal für KIKO
40 23330 99024 3	FOA 1	rutschhemmender Adapter für FO 1	transparent		Stationärer Handel	
40 23330 99025 0	FO1 / FOA 1 montiert	Blusenbügel (mit rutschhemmenden Adapter)	glasklar	26, 33, 38, 43, 47	Stationärer Handel	weitausgeschnittene Blusen und T-Shirts

Business Terms

Business Term	EANCOM-Segment		Data Element	
	Seg.-No.	Segment SG	DEG	DE
Acknowledgement request	2	UNB		0031
Additional party identification (Buyer)	16	RFF SG2#2\SG3#4	C506	1154
Address for reverse routing	2	UNB	S002	0008
Allowance or charge amount	43	MOA SG28#3\SG43#1\SG46#1	C516	5004
Application reference	2	UNB		0026
Article condition	41	ALC SG28#3\SG43#1		5463
Barcoding information Add on	32	FTX SG28#3	C108	4440
Barcoding information for GTIN 13 Symbol	32	FTX SG28#3	C108	4440
Cancellation if not delivered	7	DTM	C507	2380
Cancellation if not delivered (line item)	29	DTM SG28#3	C507	2380
Character set	2	UNB	S001	0001
Class of goods	24	PIA SG28#3	C212	7140
Collective order number	13	RFF SG1#10	C506	1154
Component data element separator	1	UNA		UNA1
Country of receiver, coded	18	NAD SG2#8		3207
Currency code	20	CUX SG7#1	C504	6345
Currency code	35	CUX SG28#3\SG32#6	C504	6345
Data element separator	1	UNA		UNA2
Decimal notation	1	UNA		UNA3
Delivery date, requested	6	DTM	C507	2380
Delivery date, requested (detail section)	28	DTM SG28#3	C507	2380
EANCOM	2	UNB		0032
End of the transmission file, Number of messages or message groups	46	UNZ		0036
File creation date	2	UNB	S004	0017
File creation time	2	UNB	S004	0019
Free Quantity	26	QTY SG28#3	C186	6060
GLN of the receiver of goods/ services	18	NAD SG2#8	C082	3039
GLN of the ultimate consignee	19	NAD SG2#12	C082	3039
GTIN	22	LIN SG28#3	C212	7140
Identification of buyer/invoicee	15	NAD SG2#2	C082	3039
Identification of invoicee	17	NAD SG2#6	C082	3039
Identification of supplier	14	NAD SG2#1	C082	3039
Identification of the receiver of the transmission file	2	UNB	S003	0010
Identification of the sender of the transmission file	2	UNB	S002	0004
Interchange control reference, beginnig	2	UNB		0020

Business Terms

Business Term	EANCOM-Segment		Data Element	
	Seg.-No.	Segment SG	DEG	DE
Interchange control reference, end	46	UNZ		0020
Labelling price	33	PRI SG28#3\SG32#4	C509	5118
Labelling price in secondary currency	34	PRI SG28#3\SG32#6	C509	5118
Lable information, code	31	FTX SG28#3	C107	4441
Lable information, freetext	31	FTX SG28#3	C108	4440
Line item number	22	LIN SG28#3		1082
Line item reference (line level)	39	RFF SG28#3\SG33#8	C506	1154
Message reference number	3	UNH		0062
Name 1 of the receiver	18	NAD SG2#8	C080	3036
Name 1 of the ultimate cosignee	19	NAD SG2#12	C080	3036
Name 2 of the receiver	18	NAD SG2#8	C080	3036
Name 2 of the ultimate consignee	19	NAD SG2#12	C080	3036
Name 3 of the receiver	18	NAD SG2#8	C080	3036
Name 3 of the ultimate consignee	19	NAD SG2#12	C080	3036
Number of salesdepartment	40	RFF SG28#3\SG33#9	C506	1154
Number of segments within a message	45	UNT		0074
Order date (time)	5	DTM	C507	2380
Order number	4	BGM	C106	1004
Order qualifier	9	FTX	C107	4441
Order qualifier	30	FTX SG28#3	C107	4441
Order reference	10	RFF SG1#1	C506	1154
Order reference	36	RFF SG28#3\SG33#1	C506	1154
Partial Order, Status	8	ALI		4183
Partial order, Status	27	ALI SG28#3		4183
Password interchange	2	UNB	S005	0022
Percentage of allowance/charge	42	PCD SG28#3\SG43#1\SG45#1	C501	5482
Place of receiver - name of a city (town, village) for adressing purposes.	18	NAD SG2#8		3164
Place of ultimate consignee - name of a city (town, village) for adressing purposes.	19	NAD SG2#12		3164
Postcode of receiver	18	NAD SG2#8		3251
Postcode of ultimate consignee	19	NAD SG2#12		3251
Promotion deal number	12	RFF SG1#4	C506	1154
Promotion deal number (line level)	38	RFF SG28#3\SG33#5	C506	1154
Quantity	25	QTY SG28#3	C186	6060
Release character	1	UNA		UNA4

Business Terms

Business Term	EANCOM-Segment		Data Element	
	Seg.-No.	Segment SG	DEG	DE
Reserved for future use	1	UNA		UNA5
Routing address	2	UNB	S003	0014
Segment terminator	1	UNA		UNA6
Sellers reference number	11	RFF SG1#3	C506	1154
Sellers reference number	37	RFF SG28#3\SG33# 2	C506	1154
Street and number of receiver	18	NAD SG2#8	C059	3042
Street of ultimate consignee	19	NAD SG2#12	C059	3042
Supplier's article number	23	PIA SG28#3	C212	7140
Syntax version	2	UNB	S001	0002
Test indicator	2	UNB		0035
Transport means	21	TDT SG10#2	C228	8179
Type of order	4	BGM	C002	1001

Branching Diagram

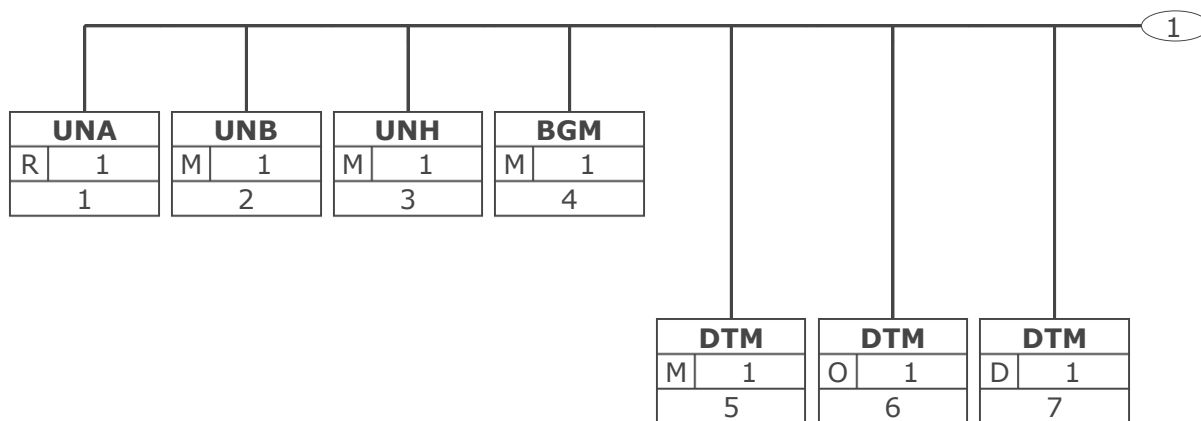

Tag	Tag = Segment/Group Tag
St MaxOcc	St = Status (M=Mandatory, C=Conditional, R=Required, O=Optional, A=Advised, D=Dependent)
No	MaxOcc = Maximum occurrence of the segment/group; No = Consecutive segment number

Branching Diagram

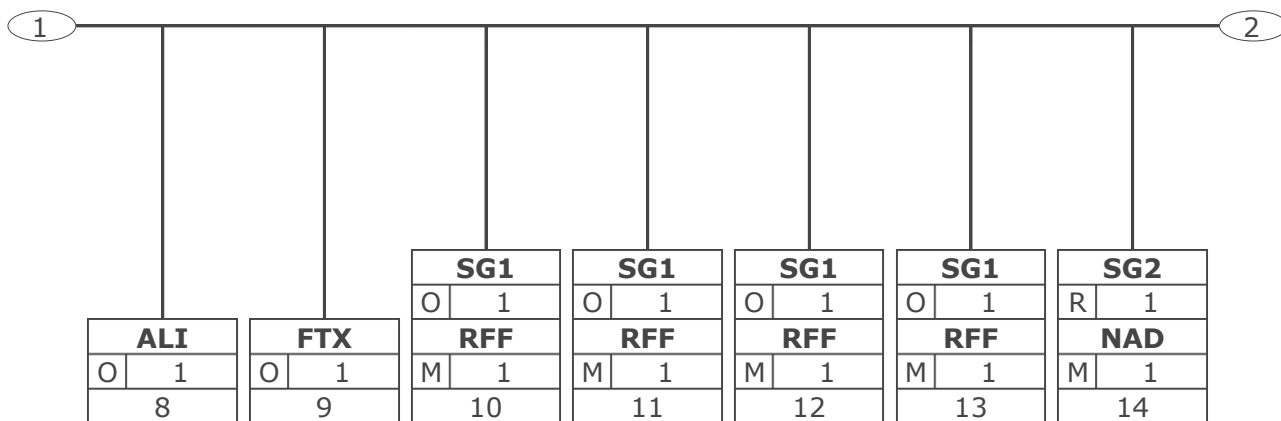

Tag	Tag = Segment/Group Tag
St MaxOcc	St = Status (M=Mandatory, C=Conditional, R=Required, O=Optional, A=Advised, D=Dependent)
No	MaxOcc = Maximum occurrence of the segment/group; No = Consecutive segment number

Branching Diagram

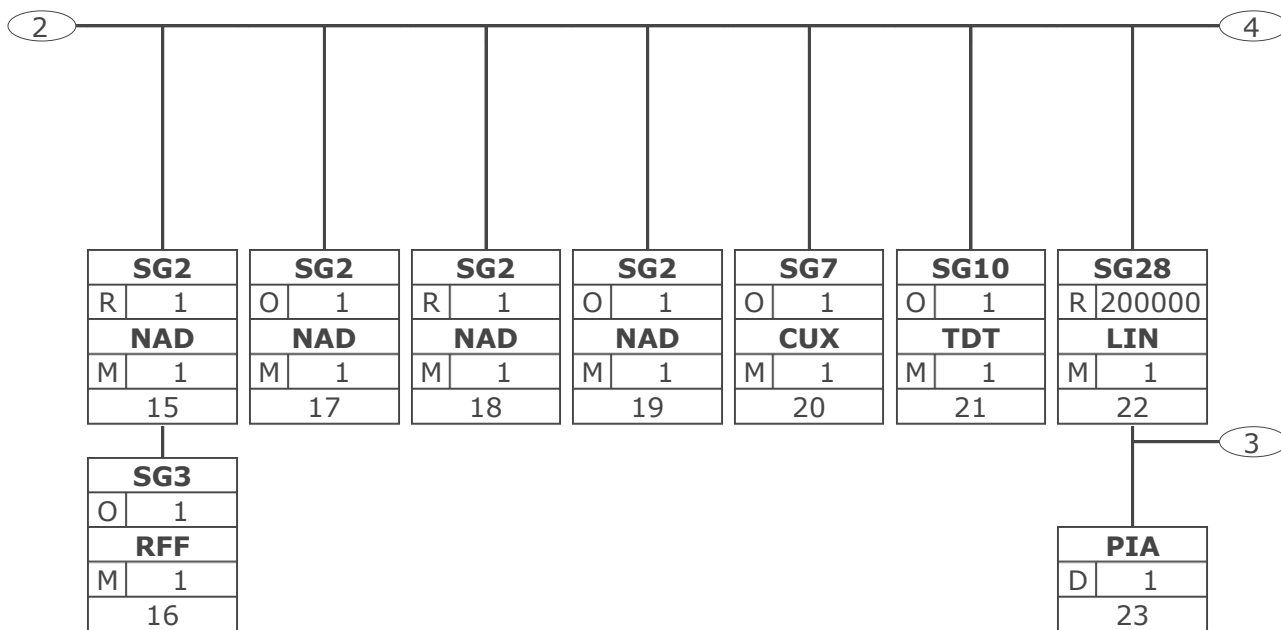

Tag	Tag = Segment/Group Tag
St	MaxOcc St = Status (M=Mandatory, C=Conditional, R=Required, O=Optional, A=Advised, D=Dependent)
No	MaxOcc = Maximum occurrence of the segment/group; No = Consecutive segment number

Branching Diagram

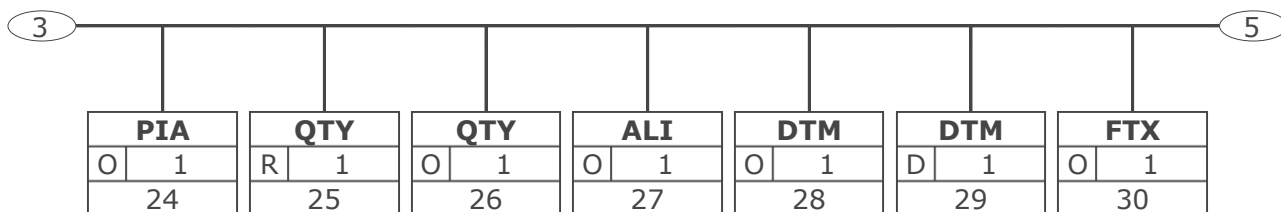

Tag	Tag = Segment/Group Tag
St MaxOcc	St = Status (M=Mandatory, C=Conditional, R=Required, O=Optional, A=Advised, D=Dependent)
No	MaxOcc = Maximum occurrence of the segment/group; No = Consecutive segment number

Branching Diagram

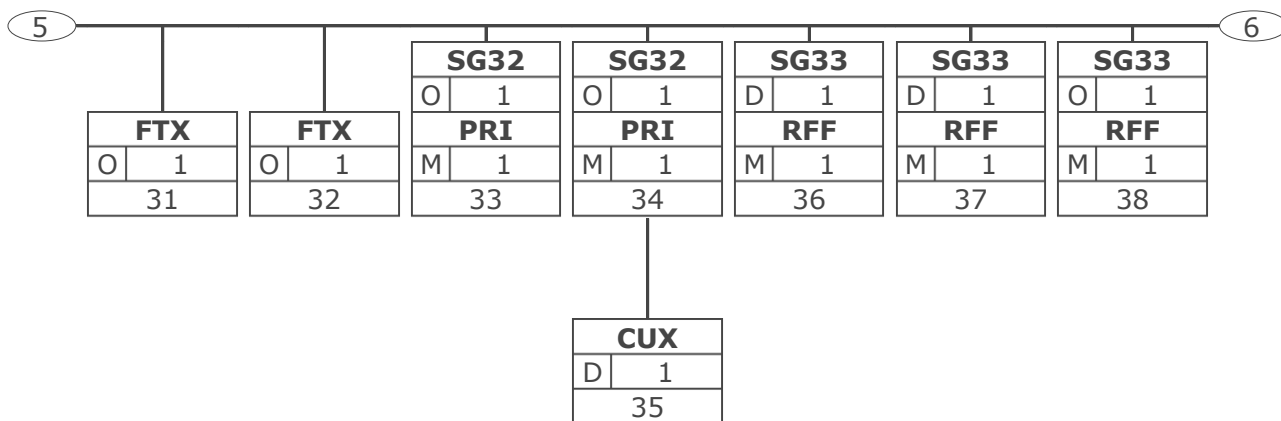

Tag	Tag = Segment/Group Tag
St MaxOcc	St = Status (M=Mandatory, C=Conditional, R=Required, O=Optional, A=Advised, D=Dependent)
No	MaxOcc = Maximum occurrence of the segment/group; No = Consecutive segment number

Branching Diagram

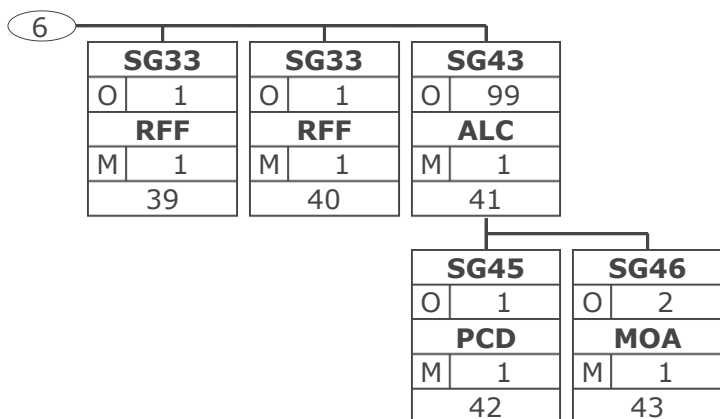

Tag	Tag = Segment/Group Tag
St MaxOcc	St = Status (M=Mandatory, C=Conditional, R=Required, O=Optional, A=Advised, D=Dependent)
No	MaxOcc = Maximum occurrence of the segment/group; No = Consecutive segment number

Branching Diagram

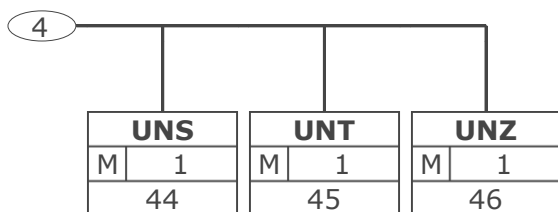

Tag	Tag = Segment/Group Tag
St	MaxOcc St = Status (M=Mandatory, C=Conditional, R=Required, O=Optional, A=Advised, D=Dependent)
No	MaxOcc = Maximum occurrence of the segment/group; No = Consecutive segment number

Message Structure

Seg.	No.	Status	Max Occ	Segment
UNA	1	R	1	Used character set
UNB	2	M	1	Beginning of transmission file
Heading section				
UNH	3	M	1	Beginn of message
BGM	4	M	1	Book order
DTM	5	M	1	Order date (time)
DTM	6	O	1	Delivery date book, requested
DTM	7	D	1	Cancellation if not delivered
ALI	8	O	1	Partial order
FTX	9	O	1	Order qualifier
SG1		O	1	RFF-DTM
RFF	10	M	1	Order reference
SG1		O	1	RFF-DTM
RFF	11	M	1	Sellers reference
SG1		O	1	RFF-DTM
RFF	12	M	1	Promotion deal number
SG1		O	1	RFF-DTM
RFF	13	M	1	Collective order number
SG2		R	1	NAD-LOC-FII-SG3-SG5
NAD	14	M	1	Identification of supplier
SG2		R	1	NAD-LOC-FII-SG3-SG5
NAD	15	M	1	Identification of buyer/invoicee
SG3		O	1	RFF
RFF	16	M	1	Additional party identification (Buyer)
SG2		O	1	NAD-LOC-FII-SG3-SG5
NAD	17	M	1	Identification of invoicee
SG2		R	1	NAD-LOC-FII-SG3-SG5
NAD	18	M	1	GLN of the receiver of goods/services
SG2		O	1	NAD-LOC-FII-SG3-SG5
NAD	19	M	1	GLN of the ultimate consignee
SG7		O	1	CUX-DTM
CUX	20	M	1	Currency code
SG10		O	1	TDT-SG11
TDT	21	M	1	Transport means
Detail section				
SG28		R	200000	LIN-PIA-IMD-MEA-QTY-ALI-DTM-MOA-GIN-QVR-FTX-SG32-SG33-SG34-SG37-SG38-SG39-SG43-SG49
LIN	22	M	1	GTIN article number
PIA	23	D	1	Suppliers article number
PIA	24	O	1	Class of goods
QTY	25	R	1	Quantity
QTY	26	O	1	Free quantity book
ALI	27	O	1	Partial order
DTM	28	O	1	Delivery date/time, requested
DTM	29	D	1	Cancellation if not delivered (Position)
FTX	30	O	1	Order qualifier
FTX	31	O	1	Label information
FTX	32	O	1	Bar code information, book

Max. Occ. = Maximum occurrence of the segment/group, Status: M=Mandatory, C=Conditional, R=Required, O=Optional, A=Advised, D=Dependent

Message Structure

Seg.	No.	Status	Max Occ	Segment
SG32		O	1	PRI-CUX-DTM
PRI	33	M	1	Label price
SG32		O	1	PRI-CUX-DTM
PRI	34	M	1	Labelling price in secondary currency
CUX	35	D	1	Currency indication
SG33		D	1	RFF-DTM
RFF	36	M	1	Order reference
SG33		D	1	RFF-DTM
RFF	37	M	1	Sellers reference
SG33		O	1	RFF-DTM
RFF	38	M	1	Promotion deal number
SG33		O	1	RFF-DTM
RFF	39	M	1	Line item reference
SG33		O	1	RFF-DTM
RFF	40	M	1	Department reference
SG43		O	99	ALC-ALI-DTM-SG44-SG45-SG46-SG47-SG48
ALC	41	M	1	Article condition
SG45		O	1	PCD-RNG
PCD	42	M	1	Allowance or charge in percent
SG46		O	2	MOA-RNG
MOA	43	M	1	Allowance or charge amount
Summary section				
UNS	44	M	1	Section control
UNT	45	M	1	End of message
UNZ	46	M	1	End of the transmission file

Max. Occ. = Maximum occurrence of the segment/group, Status: M=Mandatory, C=Conditional, R=Required, O=Optional, A=Advised, D=Dependent

Segment Layout

No. Seg	St	Max. Occ.				
2	UNB	M 1	Interchange header To start, identify and specify an interchange.			
Business Term	DE	EDIFACT	Format	St	*	Description
	S001	Syntax identifier		M		
Character set	0001	Syntax identifier	a4	M	*	UNOA UN/ECE level A UNOB UN/ECE level B UNOC UN/ECE level C UNOD UN/ECE level D UNOE UN/ECE level E UNOF UN/ECE level F
Syntax version	0002	Syntax version number	n1	M	*	3 Version 3
	S002	Interchange sender		M		
Indentification of the sender of the transmission file	0004	Sender identification	an..35	M		= Global Location Number (GLN)
	0007	Partner identification code qualifier	an..4	R	*	14 GS1
Address for reverse routing	0008	Address for reverse routing	an..14	O		See note
	S003	Interchange recipient		M		
Indentification of the receiver of the transmission file	0010	Recipient identification	an..35	M		= Global Location Number (GLN)
	0007	Partner identification code qualifier	an..4	R	*	14 GS1
Routing address	0014	Routing address	an..14	O		See note
	S004	Date/time of preparation		M		
File creation date	0017	Date of preparation	n6	M		= Dateformat JJMMTT
File creation time	0019	Time of preparation	n4	M		= Timeformat HHMM
Interchange control reference, beginnig	0020	Interchange control reference	an..14	M		= Unique senders reference
	S005	Recipient's reference, password		O		
Password interchange	0022	Recipient's reference/ password	an..14	M		
	0025	Recipient's reference/ password qualifier	an2	O	*	AA Reference BB Password
Application reference	0026	Application reference	an..14	O		Message type if the transmission fole contains only one message type
	0029	Processing priority code	a1	O	*	A Highest priority
Acknowledgement request	0031	Acknowledgement request	n1	O		
EANCOM	0032	Communications agreement ID	an..35	R		= EANCOM... EDIFACT subset identification (see note)
Test indicator	0035	Test indicator	n1	O	*	1 Interchange is a

Max. Occ. = Maximum Occurrence, St = Status, * = Restricted Codes
Status: M=Mandatory, R=Required, O=Optional, D=Dependent, A=Advised, N=Not used

Segment Layout

Business Term	DE	EDIFACT	Format	St	*	Description
						test
<p>Segmentstatus: Mandatory</p> <p>This segment is used to envelope the interchange, as well as to identify both, the party to whom the interchange is sent and the party who has sent the interchange.</p> <p>For international EDI the use of character set UNOA is recommended. For national (German) EDI the use of UNOC is reasonable because it contains lower case letters and umlauts.</p> <p>Note DE 0008: The address for reverse routing is provided by the interchange sender to inform the interchange recipient of the address within the sender's (source) system to which responding interchanges must be sent. It is recommended that the GLN be used for this purpose.</p> <p>Note DE 0014: The routing address is used to identify the receiver, if a provider adds service values for the actual receiver (e.g. consolidated companies, corporate group). The use of the identification system (e.g. GLN) has to be agreed bilaterally.</p> <p>Note DE 0020: This data element must contain a consistent sequential number per interchange between sender and receiver of the transmission.</p> <p>Note DE 0032: This data element is used to identify any underlying agreements which control the exchange of data. Within EANCOM , the identity of such agreements must start with the letters 'EANCOM', the remaining characters within the data element being filled according to bilateral agreements.</p> <p>Example: UNB+UNOC:3+4012345000009:14:4012345000018+4000004000002:14:4000004000099+181013:1043+4711+REF:AA+++EANCOM+1' The EANCOM file 4711 dated 13.10.2018, 10 h 43 is sent by the issuer identified with GLN 4012345000009 to the receiver identified with GLN 4000004000002.</p>						

Max. Occ. = Maximum Occurrence, St = Status, * = Restricted Codes
Status: M=Mandatory, R=Required, O=Optional, D=Dependent, A=Advised, N=Not used

Segment Layout

Heading section

Heading section

No. Seg	St	Max. Occ.				
3	UNH	M 1	Message header To head, identify and specify a message.			
Business Term	DE	EDIFACT	Format	St	*	Description
Message reference number	0062	Message reference number	an..14	M		Sender's unique message reference. Sequence number of messages in the interchange. DE 0062 in UNT will have the same value. Generated by the sender.
	S009	Message identifier		M		
	0065	Message type	an..6	M	*	ORDERS Purchase order message
	0052	Message version number	an..3	M	*	D Draft version/ UN/EDIFACT Directory
	0054	Message release number	an..3	M	*	01B Release 2001 - B
	0051	Controlling agency	an..2	M	*	UN UN/CEFACT
	0057	Association assigned code	an..6	R	*	EAN011 GS1 version control number (GS1 Permanent Code)
Segmentstatus: Mandatory						
This segment is used to head, identify and specify a message.						
Example: UNH+ME0001+ORDERS:D:01B:UN:EAN011'						
The reference number of the ORDERS message is ME0001.						

Max. Occ. = Maximum Occurrence, St = Status, * = Restricted Codes

Status: M=Mandatory, R=Required, O=Optional, D=Dependent, A=Advised, N=Not used

Segment Layout

Heading section

No. Seg	St	Max. Occ.				
4	BGM	M 1	Beginning of message			
To indicate the type and function of a message and to transmit the identifying number.						
Business Term	DE	EDIFACT	Format	St	*	Description
	C002	Document/message name		R		
Type of order	1001	Document name code	an..3	R	*	220 Order 224 Rush order 227 Consignment order 725 Manufacturer raised order
	1131	Code list identification code	an..17	N		
	3055	Code list responsible agency code	an..3	D	*	9 GS1
	1000	Document name	an..35	O		
	C106	Document/message identification		R		
Order number	1004	Document identifier	an..35	R		Order number assigned by document sender
	1225	Message function code	an..3	R	*	9 Original 31 Copy

Segmentstatus: Mandatory

This segment is used to indicate the type and function of a message and to transmit the identifying number.

Notes to DE 1001:

220 = Order

Document/message by means of which a buyer initiates a transaction with a seller involving the supply of goods or services as specified, according to conditions set out in an offer, or otherwise known to the buyer.

224 = Rush Order

Document/message for urgent ordering.

227 = Consignment Order

Order to deliver goods into stock with agreement on payment when goods are sold out of this stock. Note: The order qualifier ACN = consignment order, no is not used.

22E = Manufacturer raised order (GS1 Code)

Document/message providing details of an order which has been raised by a manufacturer.

Example: BGM+220:::X+128576+9'

The document number is 128576.

Max. Occ. = Maximum Occurrence, St = Status, * = Restricted Codes

Status: M=Mandatory, R=Required, O=Optional, D=Dependent, A=Advised, N=Not used

Segment Layout

Heading section

No. Seg	St	Max. Occ.				
5	DTM	M 1	Date/time/period To specify date, and/or time, or period.			
Business Term	DE	EDIFACT	Format	St	*	Description
	C507	Date/time/period		M		
	2005	Date or time or period function code qualifier	an..3	M	*	137 Document/ message date/ time
Order date (time)	2380	Date or time or period value	an..35	R		
	2379	Date or time or period format code	an..3	R		102 CCYYMMDD 203 CCYYMMDDHHMM
Segmentstatus: Mandatory						
This segment is used to specify the date of the order. Identification of the 'Document/message date/time' (code value 137) is mandatory in the purchase order message.						
Example: DTM+137:20181020:102' Date of the order confirmation is the 20th of October 2018.						

Max. Occ. = Maximum Occurrence, St = Status, * = Restricted Codes
 Status: M=Mandatory, R=Required, O=Optional, D=Dependent, A=Advised, N=Not used

Segment Layout

Heading section

No. Seg	St	Max. Occ.				
6	DTM	O 1	Date/time/period To specify date, and/or time, or period.			
Business Term	DE	EDIFACT	Format	St	*	Description
	C507	Date/time/period		M		
	2005	Date or time or period function code qualifier	an..3	M	*	2 Delivery date/ time, requested
Delivery date, requested	2380	Date or time or period value	an..35	R		
	2379	Date or time or period format code	an..3	R		102 CCYYMMDD 203 CCYYMMDDHHMM 718 CCYYMMDD- CCYYMMDD 719 CCYYMMDDHHMM- CCYYMMDDHHMM Format of period to be given in actual message without hyphen.
Segmentstatus: Optional						
This segment is used to specify, where required, requested dates concerning the delivery of goods.						
DE 2005 = 2, Date on which buyer requests goods to be delivered.						
Example: DTM+2:20181028:102'						
Requested delivery date is the 28th of October 2018.						

Max. Occ. = Maximum Occurrence, St = Status, * = Restricted Codes
Status: M=Mandatory, R=Required, O=Optional, D=Dependent, A=Advised, N=Not used

Segment Layout

Heading section

No. Seg	St	Max. Occ.				
7	DTM	D 1	Date/time/period To specify date, and/or time, or period.			
Business Term	DE	EDIFACT	Format	St	*	Description
	C507	Date/time/period		M		
	2005	Date or time or period function code qualifier	an..3	M	*	61 Cancel if not delivered by this date
Cancellation if not delivered	2380	Date or time or period value	an..35	R		
	2379	Date or time or period format code	an..3	R		102 CCYYMMDD 203 CCYYMMDDHHMM
<p>Segmentstatus: Depending, Cancellation of order, if not delivered until the date requested.</p> <p>This segment is used to specify, where required, requested dates concerning the delivery of goods.</p> <p>Example: DTM+61:201810230800:203' The example request the cancellation if not delivered until the 23th of October 2018 at 8.00 a.m.</p>						

Max. Occ. = Maximum Occurrence, St = Status, * = Restricted Codes
 Status: M=Mandatory, R=Required, O=Optional, D=Dependent, A=Advised, N=Not used

Segment Layout

Heading section

No. Seg	St	Max. Occ.				
8	ALI	O 1	Additional information			
To indicate that special conditions due to the origin, customs preference, fiscal or commercial factors are applicable.						
Business Term	DE	EDIFACT	Format	St	*	Description
	3239	Country of origin name code	an..3	N		
	9213	Duty regime type code	an..3	N		
Partial Order, Status	4183	Special condition code	an..3	R		X1 No back orders when partial delivery (GS1 Temporary Code) X2 Back orders accepted when partial delivery (GS1 Temporary Code) 144 Deliver full order
<p>Segmentstatus: Optional</p> <p>This segment is only used, to identify the status of partial order.</p> <p>This indication is valid for all articles of the entire order and can be overwritten in the detail-section.</p> <p>Example: ALI+++X2' Partial order allowed</p>						

Max. Occ. = Maximum Occurrence, St = Status, * = Restricted Codes
 Status: M=Mandatory, R=Required, O=Optional, D=Dependent, A=Advised, N=Not used

Segment Layout

Heading section

No. Seg	St	Max. Occ.				
9	FTX	O 1	Free text To provide free form or coded text information.			
Business Term	DE	EDIFACT	Format	St	*	Description
	4451	Text subject code qualifier	an..3	M	*	PUR Purchasing information
	4453	Free text function code	an..3	O	*	1 Text for subsequent use
	C107	Text reference		D		
Order qualifier	4441	Free text value code	an..17	M	*	ZRN Central settlement, no ZRY Central settlement, yes OWN Do not forward order to publisher OWY Forward order to publisher RWN Remittance, no RWY Remittance, yes ACN Consignment order, no ACY Consignment order, yes PKN Backorder until agreed order volume is reached, no PKY Backorder until agreed order volume is reached, yes TUN Do not supply replacement article TUY Automatic supply of replacement article PWN Batch bonus, no PWY Batch bonus, yes DUN Do not record dues (supply only if immediately available) DUY Record dues (backorder if not immediately available)
	1131	Code list identification code	an..17	R	*	MEDIA Media (fix value)

Max. Occ. = Maximum Occurrence, St = Status, * = Restricted Codes

Status: M=Mandatory, R=Required, O=Optional, D=Dependent, A=Advised, N=Not used

Segment Layout

Heading section

Business Term	DE	EDIFACT	Format	St	*	Description
	3055	Code list responsible agency code	an..3	R	*	246 GS1 Germany

Segmentstatus: Optional

This segment is used to advice order qualifiers for the order response.

This indication is valid for all articles of the entire order response and can be overwritten in the detail-section.

Example: `FTX+PUR++DUN:MEDIA:246'`

Do not record dues.

Max. Occ. = Maximum Occurrence, St = Status, * = Restricted Codes
 Status: M=Mandatory, R=Required, O=Optional, D=Dependent, A=Advised, N=Not used

Segment Layout

Heading section

No.	Seg	St	Max. Occ.			
10	SG1	O	1	RFF-DTM		
	RFF	M	1	Reference		
To specify a reference.						
Business Term		DE	EDIFACT	Format	St	* Description
		C506	Reference		M	
		1153	Reference code qualifier	an..3	M	* CT Contract number
Order reference		1154	Reference identifier	an..70	R	
Segmentstatus: Optional						
This RFF segment is used to indicate a order reference number relevant for the entire order response.						
This indication is valid for all articles of the entire order response and can be overwritten in the detail-section.						
Example: RFF+CT:4711'						
The order is based on order reference no. 4711.						

Max. Occ. = Maximum Occurrence, St = Status, * = Restricted Codes
 Status: M=Mandatory, R=Required, O=Optional, D=Dependent, A=Advised, N=Not used

Segment Layout

Heading section

No.	Seg	St	Max. Occ.			
11	SG1	O	1	RFF-DTM		
	RFF	M	1	Reference		
To specify a reference.						
Business Term	DE	EDIFACT	Format	St	*	Description
	C506	Reference		M		
	1153	Reference code qualifier	an..3	M	*	SS Seller's reference number
Sellers reference number	1154	Reference identifier	an..70	R		
Segmentstatus: Optional						
This RFF segment is used to indicate a sellers reference number relevant for the entire order response.						
This indication is valid for all articles of the entire order response and can be overwritten in the detail-section.						
This indication is valid for all articles of the entire order and can be overwritten in the detail-section.						
Example: RFF+SS:4711'						
The order is based on sellers reference no. 4711.						

Max. Occ. = Maximum Occurrence, St = Status, * = Restricted Codes
 Status: M=Mandatory, R=Required, O=Optional, D=Dependent, A=Advised, N=Not used

Segment Layout

Heading section

No.	Seg	St	Max.	Occ.			
12	SG1	O	1		RFF-DTM		
	RFF	M	1		Reference		
To specify a reference.							
Business Term		DE	EDIFACT	Format	St	*	Description
		C506	Reference		M		
		1153	Reference code qualifier	an..3	M	*	PD Promotion deal number
Promotion deal number		1154	Reference identifier	an..70	R		
Segmentstatus: Optional							
This RFF segment is used to indicate a promotion deal number relevant for the entire order.							
This indication is valid for all articles of the entire order and can be overwritten in the detail-section.							
Example: RFF+PD:4711'							
The order is based on promotion deal no. 4711.							

Max. Occ. = Maximum Occurrence, St = Status, * = Restricted Codes
 Status: M=Mandatory, R=Required, O=Optional, D=Dependent, A=Advised, N=Not used

Segment Layout

Heading section

No. Seg	St	Max. Occ.				
13	SG1	O 1	RFF-DTM			
	RFF	M 1	Reference			
To specify a reference.						
Business Term	DE	EDIFACT	Format	St	*	Description
	C506	Reference		M		
	1153	Reference code qualifier	an..3	M	*	ECN External consolidation reference number (GS1 Temporary Code)
Collective order number	1154	Reference identifier	an..70	R		
Segmentstatus: Optional						
This RFF segment is used to indicate a collective order number.						
Example: RFF+ECN:15687'						
The order is based on the collective order number 15687.						

Max. Occ. = Maximum Occurrence, St = Status, * = Restricted Codes
 Status: M=Mandatory, R=Required, O=Optional, D=Dependent, A=Advised, N=Not used

Segment Layout

Heading section

No. Seg	St	Max. Occ.				
14	SG2	R 1	NAD-LOC-FII-SG3-SG5			
	NAD	M 1	Name and address			
To specify the name/address and their related function, either by C082 only and/or unstructured by C058 or structured by C080 thru 3207.						
Business Term	DE	EDIFACT	Format	St	*	Description
	3035	Party function code qualifier	an..3	M	*	SU Supplier
	C082	Party identification details		A		
Identification of supplier	3039	Party identifier	an..35	M		Global Location Number (GLN) - Format n13
	1131	Code list identification code	an..17	N		
	3055	Code list responsible agency code	an..3	R	*	9 GS1
	C058	Name and address		O		This composite may only be used to fulfill the requirements of directive 2003/58/EG, article 4. If applicable the message sender gets the possibility to give the relevant statements at this place. If C058 ist not sufficient, more declaration can be given in following RFF+GN... segments.
	3124	Name and address description	an..35	M		
	3124	Name and address description	an..35	O		
	3124	Name and address description	an..35	O		
	3124	Name and address description	an..35	O		
	3124	Name and address description	an..35	O		
Segmentstatus: Mandatory						
Within EANCOM it is mandatory to identify the supplier/manufacturer by Global Location Number (GLN).						
Example: NAD+SU+4012345000009::9+X:X:X:X:X'						
The supplier/manufacturer is identified by Global Location Number (GLN) 4012345000009.						

Max. Occ. = Maximum Occurrence, St = Status, * = Restricted Codes
 Status: M=Mandatory, R=Required, O=Optional, D=Dependent, A=Advised, N=Not used

Segment Layout

Heading section

No. Seg	St	Max. Occ.				
15	SG2	R 1	NAD-LOC-FII-SG3-SG5			
	NAD	M 1	Name and address			
To specify the name/address and their related function, either by C082 only and/or unstructured by C058 or structured by C080 thru 3207.						
Business Term	DE	EDIFACT	Format	St	*	Description
	3035	Party function code qualifier	an..3	M	*	BY Buyer
	C082	Party identification details		A		
Identification of buyer/ invoicee	3039	Party identifier	an..35	M		Global Location Number (GLN) - Format n13
	1131	Code list identification code	an..17	N		
	3055	Code list responsible agency code	an..3	R	*	9 GS1
	C058	Name and address		O		This composite may only be used to fulfill the requirements of directive 2003/58/EG, article 4. If applicable the message sender gets the possibility to give the relevant statements at this place. If C058 ist not sufficient, more declaration can be given in following RFF+GN... segments.
	3124	Name and address description	an..35	M		
	3124	Name and address description	an..35	O		
	3124	Name and address description	an..35	O		
	3124	Name and address description	an..35	O		
	3124	Name and address description	an..35	O		
Segmentstatus: Mandatory						
Within EANCOM it is mandatory to identify the buyer/invoicee by Global Location Number (GLN).						
Example: NAD+BY+4398765000004::9+X:X:X:X:X'						
The order is generated by a buyer with the Global Location Number (GLN) 4398765000004.						

Max. Occ. = Maximum Occurrence, St = Status, * = Restricted Codes
 Status: M=Mandatory, R=Required, O=Optional, D=Dependent, A=Advised, N=Not used

Segment Layout

Heading section

No. Seg	St	Max. Occ.				
16	SG2	R 1	NAD-LOC-FII-SG3-SG5			
	SG3	O 1	RFF			
	RFF	M 1	Reference			
To specify a reference.						
Business Term	DE	EDIFACT	Format	St	*	Description
	C506	Reference		M		
	1153	Reference code qualifier	an..3	M	*	YC1 Additional party identification (GS1 Temporary Code)
Additional party identification (Buyer)	1154	Reference identifier	an..70	R		
Segmentstatus: Optional						
<p>This segment is used to provide reference numbers concerning the partners identified in preceding NAD segment. The use of this segment needs to be mutually agreed between the trading partners.</p> <p>If no functional or organisational differences are necessary within one company only the GLN is used for communication purposes, if applicable the receiver links within the inhouse system. Additional identifications should be agreed only in those cases when different functional entities need to be distinguished at one location.</p> <p>Example: RFF+YC1:22369' The additional party identification (customer) is 22369.</p>						

Max. Occ. = Maximum Occurrence, St = Status, * = Restricted Codes
 Status: M=Mandatory, R=Required, O=Optional, D=Dependent, A=Advised, N=Not used

Segment Layout

Heading section

No. Seg	St	Max. Occ.				
17	SG2	O 1	NAD-LOC-FII-SG3-SG5			
	NAD	M 1	Name and address			
To specify the name/address and their related function, either by C082 only and/or unstructured by C058 or structured by C080 thru 3207.						
Business Term	DE	EDIFACT	Format	St	*	Description
	3035	Party function code qualifier	an..3	M	*	IV Invoicee
	C082	Party identification details		R		
Identification of invoicee	3039	Party identifier	an..35	M		Global Location Number (GLN) - Format n13
	1131	Code list identification code	an..17	N		
	3055	Code list responsible agency code	an..3	R	*	9 GS1
Segmentstatus: Optional						
Within EANCOM it is mandatory to identify the invoicee by Global Location Number (GLN). This specification is only necessary, if the buyer differs from the invoicee.						
Example: NAD+IV+4012345000009::9' The invoicee is identified by Global Location Number (GLN) 4012345000009.						

Max. Occ. = Maximum Occurrence, St = Status, * = Restricted Codes
Status: M=Mandatory, R=Required, O=Optional, D=Dependent, A=Advised, N=Not used

Segment Layout

Heading section

No. Seg	St	Max. Occ.				
18	SG2	R 1	NAD-LOC-FII-SG3-SG5			
	NAD	M 1	Name and address			
To specify the name/address and their related function, either by C082 only and/or unstructured by C058 or structured by C080 thru 3207.						
Business Term	DE	EDIFACT	Format	St	*	Description
	3035	Party function code qualifier	an..3	M	*	DP Delivery party
	C082	Party identification details		D		
GLN of the receiver of goods/services	3039	Party identifier	an..35	M		Global Location Number (GLN) - Format n13
	1131	Code list identification code	an..17	N		
	3055	Code list responsible agency code	an..3	R	*	9 GS1
	C058	Name and address		N		
	3124	Name and address description	an..35			
	C080	Party name		D		
Name 1 of the receiver	3036	Party name	an..35	M		
Name 2 of the receiver	3036	Party name	an..35	D		
Name 3 of the receiver	3036	Party name	an..35	D		
	C059	Street		D		
Street and number of receiver	3042	Street and number or post office box identifier	an..35	M		
Place of receiver - name of a city (town, village) for addressing purposes.	3164	City name	an..35	D		
	C819	Country sub-entity details		D		
	3229	Country sub-entity name code	an..9	O		Identification of the name of sub-entities (state, province) defined by appropriate governmental agencies
Postcode of receiver	3251	Postal identification code	an..17	D		
Country of receiver, coded	3207	Country name code	an..3	D		
Segmentstatus: Mandatory						
This NAD segment always identifies the first delivery place.						
The NAD segment is used to specify names, address and function of a partner, either only by data element group C082 and/or in structure form by data element group C080 to 3707.						
Use of GLN, the specification of the Global Location Number is sufficient.						

Max. Occ. = Maximum Occurrence, St = Status, * = Restricted Codes
 Status: M=Mandatory, R=Required, O=Optional, D=Dependent, A=Advised, N=Not used

Segment Layout

Heading section

For receivers, who do not have GLN, the address is indicated as clear text. The group C082 remains empty in this case.

Example: NAD+DP+4399899175941::9++EDI-LAND:Herr Laufen:Garage+Bussardweg 5+Leopardshöhle++3818+DE'

The receiver is identified by Global Location Number (GLN) 4399899175941. An address in clear text is only allowed in exceptional cases.

Segment Layout

Heading section

No. Seg	St	Max. Occ.				
19	SG2	O 1	NAD-LOC-FII-SG3-SG5			
	NAD	M 1	Name and address			
To specify the name/address and their related function, either by C082 only and/or unstructured by C058 or structured by C080 thru 3207.						
Business Term	DE	EDIFACT	Format	St	*	Description
	3035	Party function code qualifier	an..3	M	*	UC Ultimate consignee
	C082	Party identification details		D		
GLN of the ultimate consignee	3039	Party identifier	an..35	M		Global Location Number (GLN) - Format n13
	1131	Code list identification code	an..17	N		
	3055	Code list responsible agency code	an..3	R	*	9 GS1
	C058	Name and address		N		
	3124	Name and address description	an..35			
	C080	Party name		D		
Name 1 of the ultimate consignee	3036	Party name	an..35	M		
Name 2 of the ultimate consignee	3036	Party name	an..35	D		
Name 3 of the ultimate consignee	3036	Party name	an..35	D		
	C059	Street		D		
Street of ultimate consignee	3042	Street and number or post office box identifier	an..35	M		
Place of ultimate consignee - name of a city (town, village) for addressing purposes.	3164	City name	an..35	D		
	C819	Country sub-entity details		D		
	3229	Country sub-entity name code	an..9	O		
Postcode of ultimate consignee	3251	Postal identification code	an..17	D		
	3207	Country name code	an..3	D		ISO 3166 two alpha code
Segmentstatus: Optional						
This NAD segment is used to specify name and address of the ultimate consignee. If the warehouse is the delivery party (DE 3035 = DP) and the consignment is addressed to a specific outlet, that outlet is identified as ultimate consignee.						
Use of the GLN, the specification of the Global Location Number is sufficient.						

Max. Occ. = Maximum Occurrence, St = Status, * = Restricted Codes
 Status: M=Mandatory, R=Required, O=Optional, D=Dependent, A=Advised, N=Not used

Segment Layout

Heading section

For ultimate consignees, who do not have GLN, the address is indicated as clear text. The group C082 remains empty in this case.

Example: NAD+UC+4399899175941::9++EDI-LAND:Herr Laufen:Garage+Bussardweg 5+Leopardshöhle++3818+DE'

The ultimate consignee is identified by Global Location Number (GLN) 4399899175941.
An address in clear text is only allowed in exceptional cases.

Segment Layout

Heading section

No. Seg	St	Max. Occ.				
20	SG7	O 1	CUX-DTM			
	CUX	M 1	Currencies			
To specify currencies used in the transaction and relevant details for the rate of exchange.						
Business Term	DE	EDIFACT	Format	St	*	Description
	C504	Currency details		R		
	6347	Currency usage code qualifier	an..3	M	*	2 Reference currency
Currency code	6345	Currency identification code	an..3	R		ISO 4217 3-Alpha Code
	6343	Currency type code qualifier	an..3	R	*	9 Order currency
Segmentstatus: Optional						
This segment is used to indicate currency specification for the entire order.						
Example: CUX+2:EUR:9'						
Order Currency is EURO						

Max. Occ. = Maximum Occurrence, St = Status, * = Restricted Codes
 Status: M=Mandatory, R=Required, O=Optional, D=Dependent, A=Advised, N=Not used

Segment Layout

Heading section

No. Seg	St	Max. Occ.				
21	SG10	O 1	TDT-SG11			
	TDT	M 1	Details of transport			
To specify the transport details such as mode of transport, means of transport, its conveyance reference number and the identification of the means of transport.						
Business Term	DE	EDIFACT	Format	St	*	Description
	8051	Transport stage code qualifier	an..3	M		20 Main-carriage transport
	8028	Means of transport journey identifier	an..17	N		
	C220	Mode of transport		N		
	8067	Transport mode name code	an..3			
	C228	Transport means		O		
Transport means	8179	Transport means description code	an..8	D		31 Truck 48 Van 21E Flat lorry 15t (GS1 Temporary Code) X04 Courier express (GS1 Temporary Code) X09 Parcel post (GS1 Temporary Code) X11 Surface mail (GS1 Temporary Code) X12 Accelerated surface mail (GS1 Temporary Code) X14 Printed matter/book post (GS1 Temporary Code) All codes can be used.
	8178	Transport means description	an..17	D		
	C040	Carrier		O		
	3127	Carrier identifier	an..17	O		GLN of the carrier
	1131	Code list identification code	an..17	N		
	3055	Code list responsible agency code	an..3	R		9 GS1
	3128	Carrier name	an..35	O		
Segmentstatus: Optional This segment is used to specify transport instructions for the whole Purchase Order, such as requesting an express transport service. Example: TDT+20+++31+4012345123456::9:Transport GmbH Schnelle Bücher' road parcel express: "Transport GmbH Schnelle Bücher"						

Max. Occ. = Maximum Occurrence, St = Status, * = Restricted Codes
 Status: M=Mandatory, R=Required, O=Optional, D=Dependent, A=Advised, N=Not used

Segment Layout

Detail section

No. Seg	St	Max. Occ.				
22	SG28	R 200000	LIN-PIA-IMD-MEA-QTY-ALI-DTM-MOA-GIN-QVR-FTX-SG32-SG33-SG34-SG37-SG38-SG39-SG43-SG49			
	LIN	M 1	Line item To identify a line item and configuration.			
Business Term	DE	EDIFACT	Format	St	*	Description
Line item number	1082	Line item identifier	an..6	R		Application generated line item number
	1229	Action request/ notification description code	an..3	N		
	C212	Item number identification		D		
GTIN	7140	Item identifier	an..35	R		GTIN, Format n..14
	7143	Item type identification code	an..3	R	*	SRV GS1 Global Trade Item Number
Segmentstatus: Mandatory						
The LIN-segment is used to specify the item being ordered.						
In this segment the GTIN is indicated as item identification.						
The detail section always starts with the LIN-segment.						
Example: LIN+3++4000004000033:SRV'						
The ordered item with the item number 3 is identified by GTIN 4000004000035.						

Max. Occ. = Maximum Occurrence, St = Status, * = Restricted Codes
 Status: M=Mandatory, R=Required, O=Optional, D=Dependent, A=Advised, N=Not used

Segment Layout

Detail section

No. Seg	St	Max. Occ.				
SG28	R	200000	LIN-PIA-IMD-MEA-QTY-ALI-DTM-MOA-GIN-QVR-FTX-SG32-SG33-SG34-SG37-SG38-SG39-SG43-SG49			
23			PIA	D	1	Additional product id To specify additional or substitutional item identification codes.
Business Term	DE	EDIFACT	Format	St	*	Description
	4347	Product identifier code qualifier	an..3	M	*	5 Product identification
	C212	Item number identification		M		
Supplier's article number	7140	Item identifier	an..35	R		
	7143	Item type identification code	an..3	R	*	SA Supplier's article number
	1131	Code list identification code	an..17	N		
	3055	Code list responsible agency code	an..3	R	*	91 Assigned by supplier or supplier's agent
Segmentstatus: Optional, if LIN segment does not provide a GTIN, otherwise segment is not used.						
<p>This segment is only used, if LIN segment does not provide a GTIN. Then it must follow the LIN segment immediately. In this case LIN segment (mandatory) only provides the line item number. Identification of the article is done by use of the suppliers article number in this PIA segment, DE 4347 is filled with "5" for primary identification.</p> <p>Book: ISBN13 or the suppliers article number can be used as primary identification. The application of both numbering systems at the same time is not allowed, if DE 4347 filled with "5" for primary identification is used.</p> <p>Example: PIA+5+ABC5343:SA: :91' Only if LIN does not provide a GTIN: Item identification in PIA</p>						

Max. Occ. = Maximum Occurrence, St = Status, * = Restricted Codes
Status: M=Mandatory, R=Required, O=Optional, D=Dependent, A=Advised, N=Not used

Segment Layout

Detail section

No. Seg	St	Max. Occ.				
24	SG28	R 200000	LIN-PIA-IMD-MEA-QTY-ALI-DTM-MOA-GIN-QVR-FTX-SG32-SG33-SG34-SG37-SG38-SG39-SG43-SG49			
	PIA	O 1	Additional product id To specify additional or substitutional item identification codes.			
Business Term	DE	EDIFACT	Format	St	*	Description
	4347	Product identifier code qualifier	an..3	M	*	1 Additional identification
	C212	Item number identification		M		
Class of goods	7140	Item identifier	an..35	R		
	7143	Item type identification code	an..3	R	*	GB Buyer's internal product group code
	1131	Code list identification code	an..17	N		
	3055	Code list responsible agency code	an..3	R	*	92 Assigned by buyer or buyer's agent
Segmentstatus: Optional						
This segment is used to display the class of goods.						
Example: PIA+1+4711:GB::92'						
The article belongs to the class of goods "4711"						

Max. Occ. = Maximum Occurrence, St = Status, * = Restricted Codes
 Status: M=Mandatory, R=Required, O=Optional, D=Dependent, A=Advised, N=Not used

Segment Layout

Detail section

No. Seg	St	Max. Occ.				
25			SG28	R	200000	LIN-PIA-IMD-MEA-QTY-ALI-DTM-MOA-GIN-QVR-FTX-SG32-SG33-SG34-SG37-SG38-SG39-SG43-SG49
			QTY	R	1	Quantity To specify a pertinent quantity.
Business Term	DE	EDIFACT	Format	St	*	Description
	C186	Quantity details		M		
	6063	Quantity type code qualifier	an..3	M	*	21 Ordered quantity
Quantity	6060	Quantity	an..35	M		Note: Use only numeric values.
	6411	Measurement unit code	an..3	D		KGM kilogram LTR litre MTR metre All code values from EANCOM code list 6411 and UN/ECE Recommendation 20 code list available.
<p>Segmentstatus: Mandatory</p> <p>The QTY segment is used to specify the order quantity for the current order item, which was identified in the LIN segment.</p> <p>DE 6411 is only used, if the article is a variable quantity article. Default value is piece.</p> <p>Example: QTY+21:20' The ordered quantity amounts to 20 pieces of the article no. described in the LIN segment. (GTIN).</p>						

Max. Occ. = Maximum Occurrence, St = Status, * = Restricted Codes
 Status: M=Mandatory, R=Required, O=Optional, D=Dependent, A=Advised, N=Not used

Segment Layout

Detail section

No. Seg	St	Max. Occ.				
26	SG28	R 200000	LIN-PIA-IMD-MEA-QTY-ALI-DTM-MOA-GIN-QVR-FTX-SG32-SG33-SG34-SG37-SG38-SG39-SG43-SG49			
	QTY	O 1	Quantity To specify a pertinent quantity.			
Business Term	DE	EDIFACT	Format	St	*	Description
	C186	Quantity details		M		
	6063	Quantity type code qualifier	an..3	M	*	192 Free goods quantity
Free Quantity	6060	Quantity	an..35	M		Use only numeric values.
Segmentstatus: Optional						
The QTY segment is used to specify the free quantity for the current order item, which was identified in the LIN segment. The free quantity is additional to the ordered quantity.						
Example: QTY+192:20' The free quantity amounts to 20 pieces of the article no. described in the LIN segment. (GTIN).						

Max. Occ. = Maximum Occurrence, St = Status, * = Restricted Codes
 Status: M=Mandatory, R=Required, O=Optional, D=Dependent, A=Advised, N=Not used

Segment Layout

detail section

No. Seg	St	Max. Occ.				
27	SG28	R 200000	LIN-PIA-IMD-MEA-QTY-ALI-DTM-MOA-GIN-QVR-FTX-SG32-SG33-SG34-SG37-SG38-SG39-SG43-SG49			
	ALI	O 1	Additional information To indicate that special conditions due to the origin, customs preference, fiscal or commercial factors are applicable.			
Business Term	DE	EDIFACT	Format	St	*	Description
	3239	Country of origin name code	an..3	N		
	9213	Duty regime type code	an..3	N		
Partial order, Status	4183	Special condition code	an..3	R		X1 No back orders when partial delivery (GS1 Temporary Code) X2 Back orders accepted when partial delivery (GS1 Temporary Code) 144 Deliver full order
Segmentstatus: Optional						
This segment is only used, to identify the status of partial order.						
This indication overwrites the information given in the heading-section.						
Example: ALI+++X2' Partial order allowed						

Max. Occ. = Maximum Occurrence, St = Status, * = Restricted Codes
Status: M=Mandatory, R=Required, O=Optional, D=Dependent, A=Advised, N=Not used

Segment Layout

Detail section

No. Seg	St	Max. Occ.				
28	SG28	R 200000	LIN-PIA-IMD-MEA-QTY-ALI-DTM-MOA-GIN-QVR-FTX-SG32-SG33-SG34-SG37-SG38-SG39-SG43-SG49			
	DTM	O 1	Date/time/period To specify date, and/or time, or period.			
Business Term	DE	EDIFACT	Format	St	*	Description
	C507	Date/time/period		M		
	2005	Date or time or period function code qualifier	an..3	M	*	2 Delivery date/ time, requested
Delivery date, requested (detail section)	2380	Date or time or period value	an..35	R		
	2379	Date or time or period format code	an..3	R		102 CCYYMMDD 203 CCYYMMDDHHMM 718 CCYYMMDD- CCYYMMDD Format of period to be given in actual message without hyphen.

Segmentstatus: Optional

The DTM segment is used to specify date and/or time or time period. If this DTM segment is used at detail section, the specification from the heading section is overwritten.

This segment is used, if required, for requested dates concerning the delivery of goods.

DE 2005 = 2, Delivery date/time, requested: Date, to which the buyer requires the delivery of goods.

Note DE 2005: The application of this code value excludes the use of the code values 63, 64 and 69.

Example: DTM+2:20181028:102'

This example requires the delivery on 28th of October 2018.

Segment Layout

Detail section

No. Seg	St	Max. Occ.				
29	SG28	R 200000	LIN-PIA-IMD-MEA-QTY-ALI-DTM-MOA-GIN-QVR-FTX-SG32-SG33-SG34-SG37-SG38-SG39-SG43-SG49			
	DTM	D 1	Date/time/period To specify date, and/or time, or period.			
Business Term	DE	EDIFACT	Format	St	*	Description
	C507	Date/time/period		M		
	2005	Date or time or period function code qualifier	an..3	M	*	61 Cancel if not delivered by this date
Cancellation if not delivered (line item)	2380	Date or time or period value	an..35	R		
	2379	Date or time or period format code	an..3	R		102 CCYYMMDD 203 CCYYMMDDHHMM
<p>Segmentstatus: Depending, Cancellation of line item, if not delivered until the date requested.</p> <p>This segment is used to specify, where required, requested dates concerning the delivery of goods.</p> <p>Example: DTM+61:201810230800:203' The example request the cancellation if not delivered until 23th of October 2018 at 8.00 a.m.</p>						

Max. Occ. = Maximum Occurrence, St = Status, * = Restricted Codes
 Status: M=Mandatory, R=Required, O=Optional, D=Dependent, A=Advised, N=Not used

Segment Layout

Detail section

No. Seg	St	Max. Occ.				
SG28	R	200000	LIN-PIA-IMD-MEA-QTY-ALI-DTM-MOA-GIN-QVR-FTX-SG32-SG33-SG34-SG37-SG38-SG39-SG43-SG49			
30			FTX	O	1	Free text To provide free form or coded text information.
Business Term	DE	EDIFACT	Format	St	*	Description
	4451	Text subject code qualifier	an..3	M	*	PUR Purchasing information
	4453	Free text function code	an..3	O	*	1 Text for subsequent use
	C107	Text reference		D		
Order qualifier	4441	Free text value code	an..17	M	*	DUN Do not record dues (supply only if immediately available) DUY Record dues (backorder if not immediately available) ZRN Central settlement, no ZRY Central settlement, yes OWN Do not forward order to publisher OWY Forward order to publisher RWN Remittance, no RWY Remittance, yes ACN Consignment order, no ACY Consignment order, yes PKN Backorder until agreed order volume is reached, no PKY Backorder until agreed order volume is reached, yes TUN Do not supply replacement article TUY Automatic supply of replacement article PWN Batch bonus, no

Max. Occ. = Maximum Occurrence, St = Status, * = Restricted Codes
 Status: M=Mandatory, R=Required, O=Optional, D=Dependent, A=Advised, N=Not used

Segment Layout

Detail section

Business Term	DE	EDIFACT	Format	St	*	Description
						PWY Batch bonus, yes
	1131	Code list identification code	an..17	R		MEDIA Media (fix value)
	3055	Code list responsible agency code	an..3	R		246 GS1 Germany

Segmentstatus: Optional

This segment is used to advice order qualifiers for the line item.

This indication overwrites the information given in the heading-section.

Example: FTX+PUR++DUN:MEDIA:246'

Do not record dues.

Max. Occ. = Maximum Occurrence, St = Status, * = Restricted Codes
 Status: M=Mandatory, R=Required, O=Optional, D=Dependent, A=Advised, N=Not used

Segment Layout

Detail section

No. Seg	St	Max. Occ.				
31			SG28	R	200000	LIN-PIA-IMD-MEA-QTY-ALI-DTM-MOA-GIN-QVR-FTX-SG32-SG33-SG34-SG37-SG38-SG39-SG43-SG49
			FTX	O	1	Free text To provide free form or coded text information.
Business Term	DE	EDIFACT	Format	St	*	Description
	4451	Text subject code qualifier	an..3	M	*	BAJ Information to be printed on despatch advice (Old code value: DSI)
	4453	Free text function code	an..3	O	*	1 Text for subsequent use
	C107	Text reference		D		
Lable information, code	4441	Free text value code	an..17	M	*	AF Box Number BI Barcode information EA Lable type HA Handling information NE Customer name PT Price text RN Number of storage rack
	1131	Code list identification code	an..17	R	*	MEDIA Media (fix value)
	3055	Code list responsible agency code	an..3	R	*	246 GS1 Germany
	C108	Text literal		D		
Lable information, freetext	4440	Free text value	an..51	D		
	3453	Language name code	an..3	C		ISO 639 2-Alpha Code
<p>Segmentstatus: Optional</p> <p>This segment is used to advice information needed for lable printing / printing note of delivery.</p> <p>This indication overwrites the information given in the heading-section.</p> <p>Note DE4441 and DE4440: DE4441 determines the content of DE4440.</p> <p>Example: FTX+BAJ+1+NE:MEDIA:246+Max Mustermann+DE' Name of customer: Max Mustermann</p>						

Max. Occ. = Maximum Occurrence, St = Status, * = Restricted Codes
Status: M=Mandatory, R=Required, O=Optional, D=Dependent, A=Advised, N=Not used

Segment Layout

Detail section

No. Seg	St	Max. Occ.				
SG28	R	200000	LIN-PIA-IMD-MEA-QTY-ALI-DTM-MOA-GIN-QVR-FTX-SG32-SG33-SG34-SG37-SG38-SG39-SG43-SG49			
32						
FTX	O	1	Free text To provide free form or coded text information.			
Business Term	DE	EDIFACT	Format	St	*	Description
	4451	Text subject code qualifier	an..3	M	*	PAC Packing/marking information
	4453	Free text function code	an..3	O	*	1 Text for subsequent use
	C107	Text reference		N		
	4441	Free text value code	an..17			
	C108	Text literal		D		
Barcoding information for GTIN 13 Symbol	4440	Free text value	an..51	O		Used for the GTIN number printed in the GTIN 13 symbol.
Barcoding information Add on	4440	Free text value	an..51	O		Used for the information printed in the add on symbol.
Segmentstatus: Optional						
This segment is used to advice information needed for bar code printing.						
Example: FTX+PAC+1+++4012345123456'						
The GTIN 13 barcode "4012345123456" should printed on the lable.						

Max. Occ. = Maximum Occurrence, St = Status, * = Restricted Codes
 Status: M=Mandatory, R=Required, O=Optional, D=Dependent, A=Advised, N=Not used

Segment Layout

Detail section

No. Seg	St	Max. Occ.				
SG28	R	200000	LIN-PIA-IMD-MEA-QTY-ALI-DTM-MOA-GIN-QVR-FTX-SG32-SG33-SG34-SG37-SG38-SG39-SG43-SG49			
SG32	O	1	PRI-CUX-DTM			
PRI	M	1	Price details			
33	To specify price information.					
Business Term	DE	EDIFACT	Format	St	*	Description
	C509	Price information		R		
	5125	Price code qualifier	an..3	M	*	AAE Information price, excluding allowances or charges, including taxes
Labelling price	5118	Price amount	n..15	R		
	5375	Price type code	an..3	N		
	5387	Price specification code	an..3	R	*	LBL Labelling price
	5284	Unit price basis value	n..9	D		
	6411	Measurement unit code	an..3	D		H87 Piece (Old code value: PCE) EA each GRM gram KGM kilogram LTR litre MTR metre All code values from EANCOM code list 6411 and UN/ECE Recommendation 20 code list available.
Segmentstatus: Optional						
This segment is used if the supplier is requested by the customer to do the price labelling. The currency indicated in the heading section is valid.						
The currency indicated in the heading section is valid for the label price.						
Example: PRI+AAE:19.98::LBL:1:H87'						
The labeling price per piece is 19.98 EURO incl. tax.						

Max. Occ. = Maximum Occurrence, St = Status, * = Restricted Codes
Status: M=Mandatory, R=Required, O=Optional, D=Dependent, A=Advised, N=Not used

Segment Layout

Detail section

No. Seg	St	Max. Occ.				
SG28	R	200000	LIN-PIA-IMD-MEA-QTY-ALI-DTM-MOA-GIN-QVR-FTX-SG32-SG33-SG34-SG37-SG38-SG39-SG43-SG49			
SG32	O	1	PRI-CUX-DTM			
PRI	M	1	Price details			
34	To specify price information.					
Business Term	DE	EDIFACT	Format	St	*	Description
	C509	Price information		R		
	5125	Price code qualifier	an..3	M	*	AAE Information price, excluding allowances or charges, including taxes
Labelling price in secondary currency	5118	Price amount	n..15	R		
	5375	Price type code	an..3	N		
	5387	Price specification code	an..3	R	*	ALT Alternate price
	5284	Unit price basis value	n..9	D		
	6411	Measurement unit code	an..3	D		H87 Piece (Old code value: PCE) EA each GRM gram KGM kilogram LTR litre MTR metre All code values from EANCOM code list 6411 and UN/ECE Recommendation 20 code list available.
Segmentstatus: Optional						
This segmentgroup PRI-CUX is necessary if the article shall be labeled in two currencies.						
Note DE 5387: Code value "LBL" is used if the supplier is requested by the customer to do the price labelling.						
Example: PRI+AAE:10.61::ALT:1:H87'						
The labeling price per piece is 10.61 US\$ incl. tax						

Max. Occ. = Maximum Occurrence, St = Status, * = Restricted Codes
 Status: M=Mandatory, R=Required, O=Optional, D=Dependent, A=Advised, N=Not used

Segment Layout

Detail section

No. Seg	St	Max. Occ.				
SG28	R	200000	LIN-PIA-IMD-MEA-QTY-ALI-DTM-MOA-GIN-QVR-FTX-SG32-SG33-SG34-SG37-SG38-SG39-SG43-SG49			
SG32	O	1	PRI-CUX-DTM			
CUX	D	1	Currencies			
35						To specify currencies used in the transaction and relevant details for the rate of exchange.
Business Term	DE	EDIFACT	Format	St	*	Description
	C504	Currency details		R		
	6347	Currency usage code qualifier	an..3	M	*	2 Reference currency
Currency code	6345	Currency identification code	an..3	R		
	6343	Currency type code qualifier	an..3	R	*	10 Pricing currency
Segmentstatus: Depending, Mandatory if a labelling price with secondary currency is indicated.						
This segment is used to specify currency data related to the previous PRI segment, if the currency of the labeling price for the current item differs from the currency indicated in the heading section.						
Example: CUX+2:CHF:10'						
Specification of the labeling price currency						

Max. Occ. = Maximum Occurrence, St = Status, * = Restricted Codes
 Status: M=Mandatory, R=Required, O=Optional, D=Dependent, A=Advised, N=Not used

Segment Layout

Detail section

No. Seg	St	Max. Occ.				
SG28	R	200000	LIN-PIA-IMD-MEA-QTY-ALI-DTM-MOA-GIN-QVR-FTX-SG32-SG33-SG34-SG37-SG38-SG39-SG43-SG49			
SG33	D	1	RFF-DTM			
RFF	M	1	Reference			
36			To specify a reference.			
Business Term	DE	EDIFACT	Format	St	*	Description
	C506	Reference		M		
	1153	Reference code qualifier	an..3	M	*	CR Customer reference number
Order reference	1154	Reference identifier	an..70	R		
<p>Segmentstatus: Depending, Required if not specified in the Heading-Section.</p> <p>This RFF segment is used to indicate a order reference relevant for the order line.</p> <p>This indication overwrites the information given in the heading-section.</p> <p>Example: RFF+CR:4711' The order reference is 4711.</p>						

Max. Occ. = Maximum Occurrence, St = Status, * = Restricted Codes
 Status: M=Mandatory, R=Required, O=Optional, D=Dependent, A=Advised, N=Not used

Segment Layout

Detail section

No. Seg	St	Max. Occ.				
SG28	R	200000	LIN-PIA-IMD-MEA-QTY-ALI-DTM-MOA-GIN-QVR-FTX-SG32-SG33-SG34-SG37-SG38-SG39-SG43-SG49			
SG33	D	1	RFF-DTM			
37 RFF	M	1	Reference			
To specify a reference.						
Business Term	DE	EDIFACT	Format	St	*	Description
	C506	Reference		M		
	1153	Reference code qualifier	an..3	M	*	SS Seller's reference number
Sellers reference number	1154	Reference identifier	an..70	R		
Segmentstatus: Depending						
This RFF segment is used to indicate a sellers reference number relevant for the entire order.						
This indication overwrites the information given in the heading-section.						
Example: RFF+SS:4711'						
The order is based on sellers reference no. 4711.						

Max. Occ. = Maximum Occurrence, St = Status, * = Restricted Codes
 Status: M=Mandatory, R=Required, O=Optional, D=Dependent, A=Advised, N=Not used

Segment Layout

Detail section

No. Seg	St	Max. Occ.				
SG28	R	200000	LIN-PIA-IMD-MEA-QTY-ALI-DTM-MOA-GIN-QVR-FTX-SG32-SG33-SG34-SG37-SG38-SG39-SG43-SG49			
SG33	O	1	RFF-DTM			
RFF	M	1	Reference			
38			To specify a reference.			
Business Term	DE	EDIFACT	Format	St	*	Description
	C506	Reference		M		
	1153	Reference code qualifier	an..3	M	*	PD Promotion deal number
Promotion deal number (line level)	1154	Reference identifier	an..70	R		
Segmentstatus: Optional						
This RFF segment is used to indicate a promotion deal number relevant for the order line.						
This indication overwrites the information given in the heading-section.						
Example: RFF+PD:4711'						
The order line is based on promotion deal no. 4711.						

Max. Occ. = Maximum Occurrence, St = Status, * = Restricted Codes
 Status: M=Mandatory, R=Required, O=Optional, D=Dependent, A=Advised, N=Not used

Segment Layout

Detail section

No. Seg	St	Max. Occ.				
SG28	R	200000	LIN-PIA-IMD-MEA-QTY-ALI-DTM-MOA-GIN-QVR-FTX-SG32-SG33-SG34-SG37-SG38-SG39-SG43-SG49			
SG33	O	1	RFF-DTM			
39 RFF	M	1	Reference			
To specify a reference.						
Business Term	DE	EDIFACT	Format	St	*	Description
	C506	Reference		M		
	1153	Reference code qualifier	an..3	M	*	LI Line item reference number
Line item reference (line level)	1154	Reference identifier	an..70	R		
Segmentstatus: Optional						
This RFF segment is used to indicate a line item reference relevant for the order line.						
Example: RFF+LI:4711'						
The order line is based on line item reference 4711.						

Max. Occ. = Maximum Occurrence, St = Status, * = Restricted Codes
 Status: M=Mandatory, R=Required, O=Optional, D=Dependent, A=Advised, N=Not used

Segment Layout

Detail section

No. Seg	St	Max. Occ.				
SG28	R	200000	LIN-PIA-IMD-MEA-QTY-ALI-DTM-MOA-GIN-QVR-FTX-SG32-SG33-SG34-SG37-SG38-SG39-SG43-SG49			
SG33	O	1	RFF-DTM			
RFF	M	1	Reference			
40			To specify a reference.			
Business Term	DE	EDIFACT	Format	St	*	Description
	C506	Reference		M		
	1153	Reference code qualifier	an..3	M	*	SD Sales department number
Number of salesdepartment	1154	Reference identifier	an..70	R		
Segmentstatus: Optional						
This RFF segment is used to indicate a department reference relevant for the order line.						
Example: RFF+SD:4711'						
The order line is for department 4711.						

Max. Occ. = Maximum Occurrence, St = Status, * = Restricted Codes
 Status: M=Mandatory, R=Required, O=Optional, D=Dependent, A=Advised, N=Not used

Segment Layout

Detail section

No. Seg	St	Max. Occ.				
SG28	R	200000	LIN-PIA-IMD-MEA-QTY-ALI-DTM-MOA-GIN-QVR-FTX-SG32-SG33-SG34-SG37-SG38-SG39-SG43-SG49			
SG43	O	99	ALC-ALI-DTM-SG44-SG45-SG46-SG47-SG48			
ALC	M	1	Allowance or charge			
41	To identify allowance or charge details.					
Business Term	DE	EDIFACT	Format	St	*	Description
Article condition	5463	Allowance or charge code qualifier	an..3	M	*	A Allowance C Charge
	C552	Allowance/charge information		O		
	1230	Allowance or charge identifier	an..35	N		
	5189	Allowance or charge identification code	an..3	N		
	4471	Settlement means code	an..3	N		
	1227	Calculation sequence code	an..3	N		
	C214	Special services identification		O		
	7161	Special service description code	an..3	R		DI Discount Discount (document)
Segmentstatus: Optional						
This segment is used to specify any allowances or charges which are applicable for the current line item. Separate repetitions of the segmentgroup 43 must be used, if there are further allowances or charges for the same position.						
Example: ALC+A++++DI'						
Condition for information: Allowance						

Max. Occ. = Maximum Occurrence, St = Status, * = Restricted Codes
 Status: M=Mandatory, R=Required, O=Optional, D=Dependent, A=Advised, N=Not used

Segment Layout

Detail section

No. Seg	St	Max. Occ.				
SG28	R	200000	LIN-PIA-IMD-MEA-QTY-ALI-DTM-MOA-GIN-QVR-FTX-SG32-SG33-SG34-SG37-SG38-SG39-SG43-SG49			
SG43	O	99	ALC-ALI-DTM-SG44-SG45-SG46-SG47-SG48			
SG45	O	1	PCD-RNG			
42	PCD	M 1	Percentage details To specify percentage information.			
Business Term	DE	EDIFACT	Format	St	*	Description
	C501	Percentage details		M		
	5245	Percentage type code qualifier	an..3	M	*	3 Allowance or charge
Percentage of allowance/charge	5482	Percentage	n..10	R		
Segmentstatus: Optional						
This segment is used to specify percentage allowance/charge information.						
Example: PCD+3:5' 5 percent						

Max. Occ. = Maximum Occurrence, St = Status, * = Restricted Codes
 Status: M=Mandatory, R=Required, O=Optional, D=Dependent, A=Advised, N=Not used

Segment Layout

Detail section

No. Seg	St	Max. Occ.				
SG28	R	200000	LIN-PIA-IMD-MEA-QTY-ALI-DTM-MOA-GIN-QVR-FTX-SG32-SG33-SG34-SG37-SG38-SG39-SG43-SG49			
SG43	O	99	ALC-ALI-DTM-SG44-SG45-SG46-SG47-SG48			
SG46	O	2	MOA-RNG			
43 MOA	M	1	Monetary amount To specify a monetary amount.			
Business Term	DE	EDIFACT	Format	St	*	Description
	C516	Monetary amount		M		
	5025	Monetary amount type code qualifier	an..3	M	*	8 Allowance or charge amount
Allowance or charge amount	5004	Monetary amount	n..35	R		
Segmentstatus: Optional						
This segment is used to specify monetary allowance or charge amount information.						
Example: MOA+8:2.99' equals 2,99 EURO						

Max. Occ. = Maximum Occurrence, St = Status, * = Restricted Codes
Status: M=Mandatory, R=Required, O=Optional, D=Dependent, A=Advised, N=Not used

Segment Layout

Summary section
Summary section

No.	Seg	St	Max.	Occ.		
44	UNS	M	1		Section control To separate header, detail and summary sections of a message.	
Notes:						
1. To be used by message designers when required to avoid ambiguities. Mandatory only if specified for the type of message concerned.						
Business Term	DE	EDIFACT	Format	St	*	Description
	0081	Section identification	a1	M	*	S Detail/summary section separation
Segmentstatus: Mandatory						
This segment is used to separate the detail and summary section of the message.						
The UNS segment has only a syntactic function						
Example: UNS+S'						
Separation between detail and summary section						

Max. Occ. = Maximum Occurrence, St = Status, * = Restricted Codes
Status: M=Mandatory, R=Required, O=Optional, D=Dependent, A=Advised, N=Not used

Segment Layout

Summen-Teil
End of the message

No. Seg	St	Max. Occ.				
45	UNT	M 1	Message trailer To end and check the completeness of a message.			
Business Term	DE	EDIFACT	Format	St	*	Description
Number of segments within a message	0074	Number of segments in the message	n..6	M		
	0062	Message reference number	an..14	M		The reference number from the UNH segment must be repeated here Same contents as DE 0062 in the UNH segment
Segmentstatus: Mandatory						
This segment is a mandatory UN/EDIFACT segment. It must always be the last segment in the message.						
Example: UNT+182+ME0001' Number of segments in the message.						

Max. Occ. = Maximum Occurrence, St = Status, * = Restricted Codes
Status: M=Mandatory, R=Required, O=Optional, D=Dependent, A=Advised, N=Not used

Segment Layout

No. Seg	St	Max. Occ.				
46	UNZ	M 1	Interchange trailer To end and check the completeness of an interchange.			
Business Term	DE	EDIFACT	Format	St	*	Description
End of the transmission file, Number of messages or message groups	0036	Interchange control count	n..6	M		Number of messages or message groups in the transmission file.
Interchange control reference, end	0020	Interchange control reference	an..14	M		Interchange control reference, identical with UNB DE 0020.
<p>Segmentstatus: Mandatory</p> <p>The UNZ segment is the last segment of the transmission file.</p> <p>Note DE 0036: If functional groups are not used, this is the number of messages within the interchange.</p> <p>Example: UNZ+1+4711' The transmission file contains 1 message.</p>						

Max. Occ. = Maximum Occurrence, St = Status, * = Restricted Codes
Status: M=Mandatory, R=Required, O=Optional, D=Dependent, A=Advised, N=Not used

Used Codes

0001	<p>Syntax identifier Coded identification of the agency controlling a syntax and syntax level used in an interchange.</p> <p>Notes: 1. a3, upper case, Controlling Agency (e.g. UNO=UN/ECE) and a1 stating level (e.g. A) (which together give UNOA).</p>
UNOA	<p>UN/ECE level A As defined in the basic code table of ISO 646 with the exceptions of lower case letters, alternative graphic character allocations and national or application-oriented graphic character allocations.</p>
UNOB	<p>UN/ECE level B As defined in the basic code table of ISO 646 with the exceptions of alternative graphic character allocations and national or application-oriented graphic character allocations.</p>
UNOC	<p>UN/ECE level C As defined in ISO/IEC 8859-1 : Information technology - Part 1: Latin alphabet No. 1.</p>
UNOD	<p>UN/ECE level D As defined in ISO/IEC 8859-2 : Information technology - Part 2: Latin alphabet No. 2.</p>
UNOE	<p>UN/ECE level E As defined in ISO/IEC 8859-5 : Information technology - Part 5: Latin/Cyrillic alphabet.</p>
UNOF	<p>UN/ECE level F As defined in ISO 8859-7 : Information processing - Part 7: Latin/Greek alphabet.</p>
0002	<p>Syntax version number Version number of the syntax identified in the syntax identifier (0001)</p> <p>Notes: 1. Increments 1 for each version.</p>
3	<p>Version 3 ISO 9735 Amendment 1:1992. GS1 Description: Syntax version number 3. This code can be used with all of the character sets (A, B, C, D, E and F).</p>

Used Codes

0007	Partner identification code qualifier Qualifier referring to the source of codes for the identifiers of interchanging partners.
	Notes: 1. Used with sender/recipient identification code.
14	GS1 Partner identification code assigned by GS1, an international organization of GS1 Member Organizations that manages the GS1 System.
0025	Recipient's reference/password qualifier Qualifier for the recipient's reference or password.
	Notes: 1. If specified in IA.
AA	Reference Recipient's reference/password is a reference.
BB	Password Recipient's reference/password is a password.
0029	Processing priority code Code determined by the sender requesting processing priority for the interchange.
	Notes: 1. Used if specified in IA.
A	Highest priority Requested processing priority is the highest.
0031	Acknowledgement request Code determined by the sender for acknowledgement of the interchange.
	Notes: 1. Set = 1 if sender requests acknowledgement, i.e. UNB and UNZ segments received and identified.
1	Requested Acknowledgement is requested.
0035	Test indicator Indication that the interchange is a test.
	Notes: 1. Set = 1 if the interchange is a test. Otherwise not used.

Used Codes

1	Interchange is a test Indicates that the interchange is a test.
0051	Controlling agency Code to identify the agency controlling the specification, maintenance and publication of the message type.
UN	UN/CEFACT United Nations Centre for Trade Facilitation and Electronic Business (UN/CEFACT). GS1 Description: UN Economic Commission for Europe (UN/ECE), Committee on the development of trade (TRADE), Working Party on facilitation of international trade procedures (WP.4).
0052	Message version number Version number of a message type. Notes: 1. If UNG/UNE is used, shall be identical in UNG and UNE. The representation of 0052 was specified as n..3 in version 1 of ISO 9735.
D	Draft version/UN/EDIFACT Directory Message approved and issued as a draft message (Valid for directories published after March 1993 and prior to March 1997). Message approved as a standard message (Valid for directories published after March 1997).
0054	Message release number Release number within the current message type version number (0052). Notes: 1. The representation of 0054 was specified as n..3 in version 1 of ISO 9735.
01B	Release 2001 - B Message approved and issued in the second 2001 release of the UNTDID (United Nations Trade Data Interchange Directory).
0057	Association assigned code A code assigned by the association responsible for the design and maintenance of the message type concerned, which further identifies the message.
EAN011	GS1 version control number (GS1 Permanent Code) Indicates that the message is an EANCOM message in version 011.
0065	Message type Code identifying a type of message and assigned by its controlling agency. Notes: 1. Type of message being transmitted.

Used Codes

ORDERS	Purchase order message A code to identify the purchase order message. GS1 Description: Message specifying details for goods or services ordered under conditions agreed between the seller and the buyer.
0081	Section identification Separates sections in a message.
S	Detail/summary section separation To qualify the segment UNS, when separating the detail from the summary section of a message.
1001	Document name code Code specifying the document name.
220	Order Document/message by means of which a buyer initiates a transaction with a seller involving the supply of goods or services as specified, according to conditions set out in an offer, or otherwise known to the buyer.
224	Rush order Document/message for urgent ordering.
227	Consignment order Order to deliver goods into stock with agreement on payment when goods are sold out of this stock.
725	Manufacturer raised order Document/message providing details of an order which has been raised by a manufacturer. GS1 Note: Replaces GS1 Temporary Code 22E.
1131	Code list identification code Code identifying a user or association maintained code list. Notes: 1. The codes for this data element are provided by the code list responsible agency defined in data element 3055.
MEDIA	Media (fix value)
1153	Reference code qualifier Code qualifying a reference.
CR	Customer reference number Reference number assigned by the customer to a transaction.
CT	Contract number Reference number of a contract concluded between parties.

Used Codes

ECN	External consolidation reference number (GS1 Temporary Code) A reference number assigned to identify an external consolidation.
LI	Line item reference number (1156) Reference number identifying a particular line in a document.
PD	Promotion deal number Number assigned by a vendor to a special promotion activity.
SD	Sales department number A number that identifies a sales department.
SS	Seller's reference number Reference number assigned to a transaction by the seller.
YC1	Additional party identification (GS1 Temporary Code) Reference number to an additional party identification. This number may be the internal trading partner identification number used by a party to identify its trading parties.
1225	Message function code Code indicating the function of the message.
9	Original Initial transmission related to a given transaction.
31	Copy Indicates that the message is a copy of an original message that has been sent, e.g. for action or information.
2005	Date or time or period function code qualifier Code qualifying the function of a date, time or period.
2	Delivery date/time, requested Date on which buyer requests goods to be delivered.
61	Cancel if not delivered by this date The date on which cancellation should take place, if delivery has not occurred.
137	Document/message date/time (2006) Date/time when a document/message is issued. This may include authentication.
2379	Date or time or period format code Code specifying the representation of a date, time or period.
2	DDMMYY Calendar date: D = Day; M = Month; Y = Year.
101	YYMMDD Calendar date: Y = Year; M = Month; D = Day.

Used Codes

102	CCYYMMDD Calendar date: C = Century ; Y = Year ; M = Month ; D = Day.
104	MMWW-MMWW A period of time specified by giving the start week of a month followed by the end week of a month. Data is to be transmitted as consecutive characters without hyphen.
107	DDD Day's number within a specific year: D = Day.
108	WW Week's number within a specific year: W = Week.
109	MM Month's number within a specific year: M = Month.
110	DD Day's number within is a specific month.
201	YYMMDDHHMM Calendar date including time without seconds: Y = Year; M = Month; D = Day; H = Hour; M = Minute.
203	CCYYMMDDHHMM Calendar date including time with minutes: C=Century; Y=Year; M=Month; D=Day; H=Hour; M=Minutes.
204	CCYYMMDDHHMMSS Calendar date including time with seconds: C=Century;Y=Year; M=Month; D=Day;H=Hour;M=Minute;S=Second.
401	HHMM Time without seconds: H = Hour; m = Minute.
501	HHMMHHMM Time span without seconds: H = Hour; m = Minute;.
502	HHMMSS-HHMMSS Format of period to be given without hyphen.
602	CCYY Calendar year including century: C = Century; Y = Year.
609	YYMM Month within a calendar year: Y = Year; M = Month.
610	CCYYMM Month within a calendar year: CC = Century; Y = Year; M = Month.
615	YYWW Week within a calendar year: Y = Year; W = Week 1st week of January = week 01.

Used Codes

616	CCYYWW Week within a calendar year: CC = Century; Y = Year; W = Week (1st week of January = week 01).
713	YYMMDDHHMM-YYMMDDHHMM Format of period to be given in actual message without hyphen.
715	YYWW-YYWW A period of time specified by giving the start week of a year followed by the end week of year (both not including century). Data is to be transmitted as consecutive characters without hyphen.
717	YYMMDD-YYMMDD Format of period to be given in actual message without hyphen.
718	CCYYMMDD-CCYYMMDD Format of period to be given without hyphen.
719	CCYYMMDDHHMM-CCYYMMDDHHMM A period of time which includes the century, year, month, day, hour and minute. Format of period to be given in actual message without hyphen.
720	DHHMM-DHHMM Format of period to be given without hyphen (D=day of the week, 1=Monday; 2=Tuesday; ... 7=Sunday).
801	Year To indicate a quantity of years.
802	Month To indicate a quantity of months.
803	Week To indicate a quantity of weeks.
804	Day To indicate a quantity of days.
805	Hour To indicate a quantity of hours.
806	Minute To indicate a quantity of minutes.
810	Trimester To indicate a quantity of trimesters (three months).
811	Half month To indicate a quantity of half months.
21E	DDHHMM-DDHHMM (GS1 Temporary Code) Format of period to be given in actual message without hyphen.

Used Codes

3035	Party function code qualifier Code giving specific meaning to a party.
BY	Buyer Party to whom merchandise and/or service is sold.
DP	Delivery party (3144) Party to which goods should be delivered, if not identical with consignee. GS1 Description: Party to which goods should be delivered, if not the same as the buyer.
IV	Invoicee (3006) Party to whom an invoice is issued.
SU	Supplier Party who supplies goods and/or services. GS1 Description: Party which provides service(s) and/or manufactures or otherwise has possession of goods, and consigns or makes them available in trade.
UC	Ultimate consignee Party who has been designated on the invoice or packing list as the final recipient of the stated merchandise.
3055	Code list responsible agency code Code specifying the agency responsible for a code list.
2	CEC (Commission of the European Communities) Generic: see also 140, 141, 142, 162. GS1 Description: Commission of the European Communities
3	IATA (International Air Transport Association) The airline industry's international organisation. GS1 Description: International Air Transport Association
5	ISO (International Organization for Standardization) International Organization of Standardization.
6	UN/ECE (United Nations - Economic Commission for Europe) United Nations Economic Commission for Europe.
7	CEFIC (Conseil Europeen des Federations de l'Industrie Chimique) EDI project for chemical industry.
8	EDIFICE Standardised electronic commerce forum for companies with interests in computing, electronics and telecommunications. GS1 Description: EDI Forum for companies with Interest in Computing and Electronics (EDI project for EDP/ADP sector).

Used Codes

9	<p>GS1 GS1 (formerly EAN International), an organisation of GS1 Member Organisations, which manages the GS1 System. GS1 Description: GS1 International.</p>
10	<p>ODETTE Organization for Data Exchange through Tele-Transmission in Europe (European automotive industry project).</p>
17	<p>S.W.I.F.T. Society for Worldwide Interbank Financial Telecommunications s.c.</p>
28	<p>EDITEUR (European book sector electronic data interchange group) Code identifying the pan European user group for the book industry as an organisation responsible for code values in the book industry.</p>
60	<p>Assigned by national trade agency The code list is from a national agency.</p>
65	<p>GS1 France Organisation responsible for GS1 System in France.</p>
68	<p>GS1 Italy Organisation responsible for GS1 System in Italy.</p>
83	<p>US, National Retail Federation The National Retail Federation is the trade association for the general merchandise retailing industry. In addition to providing support and education services, they also maintain and publish standard colour and size codes for the retail industry.</p>
84	<p>DE, BRD (Gesetzgeber der Bundesrepublik Deutschland) German legislature.</p>
86	<p>Assigned by party originating the message Codes assigned by the party originating the message.</p>
87	<p>Assigned by carrier Codes assigned by the carrier.</p>
88	<p>Assigned by owner of operation Assigned by owner of operation (e.g. used in construction).</p>
89	<p>Assigned by distributor Codes assigned by a distributor.</p>
90	<p>Assigned by manufacturer Code assigned by the manufacturer.</p>
91	<p>Assigned by supplier or supplier's agent Codes assigned by a seller or seller's agent. GS1 Description: Code assigned by the supplier or supplier's agent.</p>

Used Codes

92	Assigned by buyer or buyer's agent Codes assigned by a buyer or buyer's agent.
112	US, U.S. Census Bureau The Bureau of the Census of the U.S. Dept. of Commerce.
113	GS1 US Organisation responsible for GS1 System in the USA.
116	US, ANSI ASC X12 American National Standards Institute ASC X12.
131	DE, German Bankers Association German Bankers' Association.
136	GS1 UK Organisation responsible for GS1 System in the UK.
137	AT, Verband oesterreichischer Banken und Bankiers Austrian bankers association.
174	DE, DIN (Deutsches Institut fuer Normung) German standardization institute.
182	US, Standard Carrier Alpha Code (Motor) Organisation maintaining the SCAC lists and transportation operating in North America.
194	AU, AQIS (Australian Quarantine and Inspection Service) Australian Quarantine and Inspection Service.
200	GS1 Netherlands Organisation responsible for GS1 System in the Netherlands.
245	GS1 Denmark Organisation responsible for GS1 System in Denmark.
246	GS1 Germany Organisation responsible for GS1 System in Germany. GS1 Description: German representative of International Article Numbering association (GS1).
260	Ediel Nordic forum A code to identify Ediel Nordic forum, which is an organization standardizing the use of EDI between the participants in the Nordic power market.
281	GS1 Belgium & Luxembourg Organisation responsible for GS1 System in Belgium & Luxembourg.
286	SE, TCO (Tjänstemännes Central Organisation) The Swedish Confederation of Professional Employees.
294	GS1 Austria Organisation responsible for the GS1 System in Austria.

Used Codes

295	AU, Therapeutic Goods Administration Austrialian administration responsible for the regulation of therapeutic goods in Australia. EDIFACT
297	IT, Ufficio IVA Ufficio responsabile gestione partite IVA, Italy (Italian Institute issuing VAT registration numbers). EDIFACT
298	GS1 Spain Organisation responsible for the GS1 System in Spain.
316	GS1 Finland Organisation responsible for the GS1 system in Finland.
317	GS1 Brazil Organisation responsible for the GS1 system in Brazil.
324	GS1 Ireland Organisation responsible for the GS1 system in Ireland.
325	GS1 Russia Organisation responsible for the GS1 system in Russia.
326	GS1 Poland Organisation responsible for the GS1 system in Poland.
327	GS1 Estonia Organisation responsible for the GS1 system in Estonia.
376	PANTONE Color code controlling organisation
400	FAO (Food and Agriculture Organisation) Food and Agriculture Organisation of the United Nations.
403	Comite Europeen de Normalisation Comite Européen de Normalisation (CEN), European committee for standardisation. GS1 Note: Replaces GS1 Temporary Code CEN.
404	Assigned by logistics service provider Codes assigned by a logistics service provider. GS1 Note: Replaces GS1 Temporary Code X6.
CEN	Comite European de Normalisation (GS1 Temporary Code) Comite European de Normalisation. GS1 Note: Code marked for deletion. Use value 403 instead.
PMS	Pantone Matching System (GS1 Temporary Code) Pantone Matching System.

Used Codes

RAL	DE, Deutsches Institut fuer Guetesicherung und Kennzeichnung (GS1 Temporary Code) German Institute for Quality Assurance and Certification.
X5	IT, Ufficio IVA (GS1 Temporary Code) Ufficio responsabile gestione partite IVA, Italy (Italian Institute issuing VAT registration numbers).
X6	Assigned by logistics service provider (GS1 Temporary Code) Codes assigned by the logistics service provider. GS1 Note: Code marked for deletion. Use value 404 instead.
ZZZ	Mutually defined A code assigned within a code list to be used on an interim basis and as defined among trading partners until a precise code can be assigned to the code list.
3207	Country name code Identification of the name of the country or other geographical entity as defined in ISO 3166-1. Notes: 1. Use ISO 3166-1 two alpha country code.
AD	ANDORRA
AE	UNITED ARAB EMIRATES
AF	AFGHANISTAN
AG	ANTIGUA AND BARBUDA
AI	ANGUILLA
AL	ALBANIA
AM	ARMENIA
AO	ANGOLA
AQ	ANTARCTICA
AR	ARGENTINA
AS	AMERICAN SAMOA
AT	AUSTRIA
AU	AUSTRALIA
AW	ARUBA
AX	ÅLAND ISLANDS
AZ	AZERBAIJAN
BA	BOSNIA AND HERZEGOVINA
BB	BARBADOS

Used Codes

BD	BANGLADESH
BE	BELGIUM
BF	BURKINA FASO
BG	BULGARIA
BH	BAHRAIN
BI	BURUNDI
BJ	BENIN
BL	SAINT BARTHÉLEMY
BM	BERMUDA
BN	BRUNEI DARUSSALAM
BO	BOLIVIA (PLURINATIONAL STATE OF)
BQ	BONAIRE, SINT EUSTATIUS AND SABA
BR	BRAZIL
BS	BAHAMAS
BT	BHUTAN
BV	BOUVET ISLAND
BW	BOTSWANA
BY	BELARUS
BZ	BELIZE
CA	CANADA
CC	COCOS (KEELING) ISLANDS
CD	CONGO, DEMOCRATIC REPUBLIC OF THE
CF	CENTRAL AFRICAN REPUBLIC
CG	CONGO
CH	SWITZERLAND
CI	COTE D'IVOIRE
CK	COOK ISLANDS
CL	CHILE
CM	CAMEROON
CN	CHINA
CO	COLOMBIA
CR	COSTA RICA
CU	CUBA

Used Codes

CV	CABO VERDE
CW	CURAÇAO
CX	CHRISTMAS ISLAND
CY	CYPRUS
CZ	CZECHIA
DE	GERMANY
DJ	DJIBOUTI
DK	DENMARK
DM	DOMINICA
DO	DOMINICAN REPUBLIC
DZ	ALGERIA
EC	ECUADOR
EE	ESTONIA
EG	EGYPT
EH	WESTERN SAHARA
ER	ERITREA
ES	SPAIN
ET	ETHIOPIA
FI	FINLAND
FJ	FIJI
FK	FALKLAND ISLANDS (MALVINAS)
FM	MICRONESIA (FEDERATED STATES OF)
FO	FAROE ISLANDS
FR	FRANCE
GA	GABON
GB	UNITED KINGDOM OF GREAT BRITAIN AND NORTHERN IRELAND
GD	GRENADA
GE	GEORGIA
GF	FRENCH GUIANA
GG	GUERNSEY
GH	GHANA
GI	GIBRALTAR
GL	GREENLAND

Used Codes

GM	GAMBIA
GN	GUINEA
GP	GUADELOUPE
GQ	EQUATORIAL GUINEA
GR	GREECE
GS	SOUTH GEORGIA AND THE SOUTH SANDWICH ISLANDS
GT	GUATEMALA
GU	GUAM
GW	GUINEA-BISSAU
GY	GUYANA
HK	HONG KONG
HM	HEARD ISLAND AND MCDONALD ISLANDS
HN	HONDURAS
HR	CROATIA
HT	HAITI
HU	HUNGARY
ID	INDONESIA
IE	IRELAND
IL	ISRAEL
IM	ISLE OF MAN
IN	INDIA
IO	BRITISH INDIAN OCEAN TERRITORY
IQ	IRAQ
IR	IRAN (ISLAMIC REPUBLIC OF)
IS	ICELAND
IT	ITALY
JE	JERSEY
JM	JAMAICA
JO	JORDAN
JP	JAPAN
KE	KENYA
KG	KYRGYZSTAN
KH	CAMBODIA

Used Codes

KI	KIRIBATI
KM	COMOROS
KN	SAINT KITTS AND NEVIS
KP	KOREA (DEMOCRATIC PEOPLE'S REPUBLIC OF)
KR	KOREA, REPUBLIC OF
KW	KUWAIT
KY	CAYMAN ISLANDS
KZ	KAZAKHSTAN
LA	LAO PEOPLE'S DEMOCRATIC REPUBLIC
LB	LEBANON
LC	SAINT LUCIA
LI	LIECHTENSTEIN
LK	SRI LANKA
LR	LIBERIA
LS	LESOTHO
LT	LITHUANIA
LU	LUXEMBOURG
LV	LATVIA
LY	LIBYA
MA	MOROCCO
MC	MONACO
MD	MOLDOVA, REPUBLIC OF
ME	MONTENEGRO
MF	SAINT MARTIN (FRENCH PART)
MG	MADAGASCAR
MH	MARSHALL ISLANDS
MK	NORTH MACEDONIA
ML	MALI
MM	MYANMAR
MN	MONGOLIA
MO	MACAO
MP	NORTHERN MARIANA ISLANDS
MQ	MARTINIQUE

Used Codes

MR	MAURITANIA
MS	MONTSERRAT
MT	MALTA
MU	MAURITIUS
MV	MALDIVES
MW	MALAWI
MX	MEXICO
MY	MALAYSIA
MZ	MOZAMBIQUE
NA	NAMIBIA
NC	NEW CALEDONIA
NE	NIGER
NF	NORFOLK ISLAND
NG	NIGERIA
NI	NICARAGUA
NL	NETHERLANDS
NO	NORWAY
NP	NEPAL
NR	NAURU
NU	NIUE
NZ	NEW ZEALAND
OM	OMAN
PA	PANAMA
PE	PERU
PF	FRENCH POLYNESIA
PG	PAPUA NEW GUINEA
PH	PHILIPPINES
PK	PAKISTAN
PL	POLAND
PM	SAINT PIERRE AND MIQUELON
PN	PITCAIRN
PR	PUERTO RICO
PS	PALESTINE, STATE OF

Used Codes

PT	PORTUGAL
PW	PALAU
PY	PARAGUAY
QA	QATAR
RE	REUNION
RO	ROMANIA
RS	SERBIA
RU	RUSSIAN FEDERATION
RW	RWANDA
SA	SAUDI ARABIA
SB	SOLOMON ISLANDS
SC	SEYCHELLES
SD	SUDAN
SE	SWEDEN
SG	SINGAPORE
SH	SAINT HELENA, ASCENSION AND TRISTAN DA CUNHA
SI	SLOVENIA
SJ	SVALBARD AND JAN MAYEN
SK	SLOVAKIA
SL	SIERRA LEONE
SM	SAN MARINO
SN	SENEGAL
SO	SOMALIA
SR	SURINAME
SS	SOUTH SUDAN
ST	SAO TOME AND PRINCIPE
SV	EL SALVADOR
SX	SINT MAARTEN (DUTCH PART)
SY	SYRIAN ARAB REPUBLIC
SZ	ESWATINI
TC	TURKS AND CAICOS ISLANDS
TD	CHAD
TF	FRENCH SOUTHERN TERRITORIES

Used Codes

TG	TOGO
TH	THAILAND
TJ	TAJIKISTAN
TK	TOKELAU
TL	TIMOR-LESTE
TM	TURKMENISTAN
TN	TUNISIA
TO	TONGA
TR	TURKEY
TT	TRINIDAD AND TOBAGO
TV	TUVALU
TW	TAIWAN, PROVINCE OF CHINA
TZ	TANZANIA, UNITED REPUBLIC OF
UA	UKRAINE
UG	UGANDA
UM	UNITED STATES MINOR OUTLYING ISLANDS
US	UNITED STATES OF AMERICA
UY	URUGUAY
UZ	UZBEKISTAN
VA	HOLY SEE
VC	SAINT VINCENT AND THE GRENADINES
VE	VENEZUELA (BOLIVARIAN REPUBLIC OF)
VG	VIRGIN ISLANDS, BRITISH
VI	VIRGIN ISLANDS, U.S.
VN	VIET NAM
VU	VANUATU
WF	WALLIS AND FUTUNA
WS	SAMOA
YE	YEMEN
YT	MAYOTTE
ZA	SOUTH AFRICA
ZM	ZAMBIA
ZW	ZIMBABWE

Used Codes

3453 Language name code
Code specifying the language name.

Notes:

1. Use ISO 639-1988.

AA	Afar
aa	Afar
AB	Abkhazian
ab	Abkhazian
AE	Avestan
ae	Avestan
AF	Afrikaans
af	Afrikaans
AK	Akan
ak	Akan
AM	Amharic
am	Amharic
AN	Aragonese
an	Aragonese
AR	Arabic
ar	Arabic
AS	Assamese
as	Assamese
AV	Avaric
av	Avaric
AY	Aymara
ay	Aymara
AZ	Azerbaijani
az	Azerbaijani
BA	Bashkir
ba	Bashkir
BE	Belarusian
be	Belarusian
BG	Bulgarian
bg	Bulgarian

Used Codes

BH	Bihari
bh	Bihari
BI	Bislama
bi	Bislama
BM	Bambara
bm	Bambara
BN	Bengali
bn	Bengali
BO	Tibetan
bo	Tibetan
BR	Breton
br	Breton
BS	Bosnian
bs	Bosnian
CA	Catalan; Valencian
ca	Catalan; Valencian
CE	Chechen
ce	Chechen
CH	Chamorro
ch	Chamorro
CO	Corsican
co	Corsican
CR	Cree
cr	Cree
CS	Czech
cs	Czech
CU	Church Slavic; Old Slavonic; Church Slavonic; Old Bulgarian; Old Church Slavonic
cu	Church Slavic; Old Slavonic; Church Slavonic; Old Bulgarian; Old Church Slavonic
CV	Chuvash
cv	Chuvash
CY	Welsh
cy	Welsh

Used Codes

DA	Danish
da	Danish
DE	German
de	German
DV	Divehi; Dhivehi; Maldivian
dv	Divehi; Dhivehi; Maldivian
DZ	Dzongkha
dz	Dzongkha
EE	Ewe
ee	Ewe
EL	Greek; Modern (1453-)
el	Greek; Modern (1453-)
EN	English
en	English
EO	Esperanto
eo	Esperanto
ES	Spanish; Castilian
es	Spanish; Castilian
ET	Estonian
et	Estonian
EU	Basque
eu	Basque
FA	Persian
fa	Persian
FF	Fulah
ff	Fulah
FI	Finnish
fi	Finnish
FJ	Fijian
fj	Fijian
FO	Faroese
fo	Faroese
FR	French

Used Codes

fr	French
FY	Western Frisian
fy	Western Frisian
GA	Irish
ga	Irish
GD	Gaelic; Scottish Gaelic
gd	Gaelic; Scottish Gaelic
GL	Galician
gl	Galician
GN	Guarani
gn	Guarani
GU	Gujarati
gu	Gujarati
GV	Manx
gv	Manx
HA	Hausa
ha	Hausa
HE	Hebrew
he	Hebrew
HI	Hindi
hi	Hindi
HO	Hiri Motu
ho	Hiri Motu
HR	Croatian
hr	Croatian
HT	Haitian; Haitian Creole
ht	Haitian; Haitian Creole
HU	Hungarian
hu	Hungarian
HY	Armenian
hy	Armenian
HZ	Herero
hz	Herero

Used Codes

IA	Interlingua (International Auxiliary Language Association)
ia	Interlingua (International Auxiliary Language Association)
ID	Indonesian
id	Indonesian
IE	Interlingue
ie	Interlingue
IG	Igbo
ig	Igbo
II	Sichuan Yi
ii	Sichuan Yi
IK	Inupiaq
ik	Inupiaq
IO	Ido
io	Ido
IS	Icelandic
is	Icelandic
IT	Italian
it	Italian
IU	Inuktiut
iu	Inuktiut
JA	Japanese
ja	Japanese
JV	Javanese
jv	Javanese
KA	Georgian
ka	Georgian
KG	Kongo
kg	Kongo
KI	Kikuyu; Gikuyu
ki	Kikuyu; Gikuyu
KJ	Kuanyama; Kwanyama
kj	Kuanyama; Kwanyama
KK	Kazakh

Used Codes

kk	Kazakh
KL	Kalaallisut; Greenlandic
kl	Kalaallisut; Greenlandic
KM	Central Khmer
km	Central Khmer
KN	Kannada
kn	Kannada
KO	Korean
ko	Korean
KR	Kanuri
kr	Kanuri
KS	Kashmiri
ks	Kashmiri
KU	Kurdish
ku	Kurdish
KV	Komi
kv	Komi
KW	Cornish
kw	Cornish
KY	Kirghiz; Kyrgyz
ky	Kirghiz; Kyrgyz
LA	Latin
la	Latin
LB	Luxembourgish; Letzeburgesch
lb	Luxembourgish; Letzeburgesch
LG	Ganda
lg	Ganda
LI	Limburgan; Limburger; Limburgish
li	Limburgan; Limburger; Limburgish
LN	Lingala
ln	Lingala
LO	Lao
lo	Lao

Used Codes

LT	Lithuanian
lt	Lithuanian
LU	Luba-Katanga
lu	Luba-Katanga
LV	Latvian
lv	Latvian
MG	Malagasy
mg	Malagasy
MH	Marshallese
mh	Marshallese
MI	Maori
mi	Maori
MK	Macedonian
mk	Macedonian
ML	Malayalam
ml	Malayalam
MN	Mongolian
mn	Mongolian
MO	Moldavian; Moldovan
mo	Moldavian; Moldovan
MR	Marathi
mr	Marathi
MS	Malay
ms	Malay
MT	Maltese
mt	Maltese
MY	Burmese
my	Burmese
NA	Nauru
na	Nauru
NB	Bokmal Norwegian; Norwegian Bokmal
nb	Bokmal Norwegian; Norwegian Bokmal
ND	Ndebele; North; North Ndebele

Used Codes

nd	Ndebele; North; North Ndebele
NE	Nepali
ne	Nepali
NG	Ndonga
ng	Ndonga
NL	Dutch; Flemish
nl	Dutch; Flemish
NN	Norwegian Nynorsk; Nynorsk, Norwegian
nn	Norwegian Nynorsk; Nynorsk, Norwegian
NO	Norwegian
no	Norwegian
NR	Ndebele; South; South Ndebele
nr	Ndebele; South; South Ndebele
NV	Navajo; Navaho
nv	Navajo; Navaho
NY	Chichewa; Chewa; Nyanja
ny	Chichewa; Chewa; Nyanja
OC	Occitan (post 1500); Provençal
oc	Occitan (post 1500); Provençal
OJ	Ojibwa
oj	Ojibwa
OM	Oromo
om	Oromo
OR	Oriya
or	Oriya
OS	Ossetian; Ossetic
os	Ossetian; Ossetic
PA	Panjabi; Punjabi
pa	Panjabi; Punjabi
PI	Pali
pi	Pali
PL	Polish
pl	Polish

Used Codes

PS	Pushto; Pashto
ps	Pushto; Pashto
PT	Portuguese
pt	Portuguese
QU	Quechua
qu	Quechua
RM	Romansh
rm	Romansh
RN	Rundi
rn	Rundi
RO	Romanian
ro	Romanian
RU	Russian
ru	Russian
RW	Kinyarwanda
rw	Kinyarwanda
SA	Sanskrit
sa	Sanskrit
SC	Sardinian
sc	Sardinian
SD	Sindhi
sd	Sindhi
SE	Northern Sami
se	Northern Sami
SG	Sango
sg	Sango
SI	Sinhala; Sinhalese
si	Sinhala; Sinhalese
SK	Slovak
sk	Slovak
SL	Slovenian
sl	Slovenian
SM	Samoan

Used Codes

sm	Samoan
SN	Shona
sn	Shona
SO	Somali
so	Somali
SQ	Albanian
sq	Albanian
SR	Serbian
sr	Serbian
SS	Swati
ss	Swati
ST	Sotho, Southern
st	Sotho, Southern
SU	Sundanese
su	Sundanese
SV	Swedish
sv	Swedish
SW	Swahili
sw	Swahili
TA	Tamil
ta	Tamil
TE	Telugu
te	Telugu
TG	Tajik
tg	Tajik
TH	Thai
th	Thai
TI	Tigrinya
ti	Tigrinya
TK	Turkmen
tk	Turkmen
TL	Tagalog
tl	Tagalog

Used Codes

TN	Tswana
tn	Tswana
TO	Tonga (Tonga Islands)
to	Tonga (Tonga Islands)
TR	Turkish
tr	Turkish
TS	Tsonga
ts	Tsonga
TT	Tatar
tt	Tatar
TW	Twi
tw	Twi
TY	Tahitian
ty	Tahitian
UG	Uighur; Uyghur
ug	Uighur; Uyghur
UK	Ukrainian
uk	Ukrainian
UR	Urdu
ur	Urdu
UZ	Uzbek
uz	Uzbek
VE	Venda
ve	Venda
VI	Vietnamese
vi	Vietnamese
VO	Volapük
vo	Volapük
WA	Walloon
wa	Walloon
WO	Wolof
wo	Wolof
XH	Xhosa

Used Codes

xh	Xhosa
YI	Yiddish
yi	Yiddish
YO	Yoruba
yo	Yoruba
ZA	Zhuang; Chuang
za	Zhuang; Chuang
ZH	Chinese
zh	Chinese
ZU	Zulu
zu	Zulu

4183

Special condition code
Code specifying a special condition.

1	Item for national preference Item concerned is applicable to national preference calculation.
2	Item qualifying for payment discount Item concerned is applicable for settlement/payment discount calculation.
3	Item not qualifying for payment discount Item concerned is not applicable for settlement/payment discount calculation.
4	Urgent delivery of reserved goods Urgent delivery of goods for which a reservation was made.
5	Item not to be included in bonus calculation Item concerned is not applicable for bonus calculation.
6	Subject to bonus Item concerned is applicable for bonus calculation.
7	Subject to commission Item concerned is applicable for commission calculation.
8	Subject to discount Item concerned is applicable for discount calculation.
9	Freely available in EU Item should be available freely within the European Economic Community. GS1 Description: Item is freely available in the European Union.
10	Subject to settlement discount Item concerned is applicable for the overall settlement discount.

Used Codes

11	Price includes excise The stated price is inclusive of excise.
12	Price includes tax The stated price is inclusive of tax.
15	Not subject to discount Item concerned is not applicable for discount calculation.
18	Item subject to national export restrictions Item concerned requires export declaration.
96	Promotional advertising A media press communication informing about a promotion.
97	Promotional price Reduction in price for a specified period of time for promotional purposes.
98	Promotional shelf display Product in promotion is displayed in a special shelf or display.
99	Safety data sheet required to accompany goods when moved Material safety data sheet is required to accompany the goods when they are moved.
109	Sale or return Item concerned may be returned to supplier or otherwise disposed of if it remains unsold after a pre-determined period of time.
116	Subject to postponed discount The item concerned is applicable for postponed discount which will be refunded via a later credit.
119	Product genetically modified An indication that a product has been genetically modified during its production process.
123	Pharmacy sales only A special condition limiting the sale of a product to a pharmacy.
124	Sale requires medical prescription The sale of the product requires a medical prescription. GS1 Description: The identified product may only be sold in conjunction with a medical prescription.
125	New item, not yet available The item is new and not yet available.
126	New, available The item is new and available.
127	Obsolete The item is obsolete.

Used Codes

128	Prototype The item is a prototype and is not yet in normal production.
129	Non-standard product This item is not a standard product.
130	Discontinued The item is no longer available.
133	Gift supplied with purchase Product made available as a gift to a customer when purchasing an accompanying product.
134	Sale from promotional stock An indication that products sold came from promotional stock.
135	Sale from obsolete stock An indication that products sold came from obsolete stock.
136	Buying group conditions A code indicating that buying group conditions apply.
137	Cancel order unless complete delivery possible on requested date and or time Code indicating that the order is to be cancelled if complete delivery is not possible on the date and or time requested in the order.
140	Return of goods Special conditions related to the return of goods.
141	Subject to annual bonus Item concerned is applicable for annual bonus calculation.
142	Invoiced but not replenished A special condition indicating the fact that goods which have not yet been replenished have been invoiced.
143	Replenished but not invoiced A special condition indicating the fact that goods which have been replenished have not yet been invoiced.
144	Deliver full order A special condition indicating that delivery of the order will only be accepted in full.
147	Special handling requirements at point of receipt An indication that the product requires special handling at the point of receipt.
148	Supply direct delivery Goods to be supplied direct delivery to the delivery store and not through a distribution centre or a warehouse.
150	Mixed item pallet Goods to be supplied on mixed item pallet.

Used Codes

151	Items from the same dye lot The items should be supplied from the same dye lot.
152	Awaiting credit clearance Processing of the referenced document is delayed while credit clearance is obtained.
153	Return publication full copies Return the full copies of a publication.
154	Return publication headings only Return only the heading of a publication.
155	Destroy publication Destroy the publication by whatever means, but in such a way that it cannot be read afterwards.
157	Not subject to sale or return Product supplied not subject to sale or return.
158	Item to be sold in both domestic and export markets The item will be sold in both the domestic and export markets.
159	Item to be sold only in export markets The item will be sold only in export markets.
164	Shipment completes order There will be no further shipments for this order as it is considered complete.
165	Split shipment Subsequent shipment(s) will arrive for this order as it has been split over more than one shipment.
166	Include in continuous replenishment calculation An indication that a product or group of products are to be included in the continuous replenishment calculation.
167	Remove from continuous replenishment calculation An indication that a product or group of products are to be removed from the continuous replenishment calculation.
168	Standard pack shipment The shipment contains only standard packs.
169	Pick pack shipment The shipment contains only packages resulting from a pick and pack operation. GS1 Description: Where the hierarchy of the shipment resulting from a pick and pack operation has the article level sub-ordinate to the packaging level.
170	Goods for retail outlet shelf Goods to be placed on a retail outlet shelf.

Used Codes

171	Security stock The goods are required to maintain the security stock.
172	Production batch number allocated A batch number is allocated by the manufacturer to the item.
173	Production batch number allocated as required by law A batch number is allocated by the manufacturer to the item as required by law.
174	Product not genetically modified An indication that a product has not been genetically modified during its production process.
175	Suspended An item whose production or distribution has been suspended. EDIFACT
176	No re-ordering The item will not be re-ordered. EDIFACT
177	Product irradiated for preservation An indication that a product has had radioactive rays directed onto it to preserve it. EDIFACT
179	Product gluten-free An indication that a product does not contain any gluten.
180	Product contains gluten An indication that a product contains gluten.
181	Product lactose-free An indication that a product does not contain any lactose.
182	Product contains lactose An indication that a product contains lactose.
183	CH, compliant with Genetically Modified Food law An indication that a product complies with the Swiss law on genetically modified food.
184	CH, non-compliant with Genetically Modified Food law An indication that a product does not comply with the Swiss law on genetically modified food.
185	CH, compliant with General Food law An indication that a product complies with the Swiss general food law.
186	CH, non-compliant with General Food law An indication that a product does not comply with the Swiss general food law.

Used Codes

187	Store may not order The store is not allowed to order.
188	Distribution centre may not order Distribution centre is not allowed to order.
189	Net content declaration indicated A declaration of a trade item's net content is on the product label.
190	Net content declaration not indicated A declaration of a trade item's net content is not on the product label.
191	Not irradiated Radiation has not been applied.
192	Batch or lot number not allocated The trade item has no batch or lot number.
193	Unsold trade item not returnable A trade item that is not sold cannot be returned.
194	Ingredient irradiated Radiation has been applied to a trade item's ingredient.
195	Ingredients not irradiated Radiation has not been applied to any trade item's ingredient.
196	Raw material irradiated Radiation has been applied to a trade item's raw material.
197	Raw material not irradiated Radiation has not been applied to any trade item's raw material.
198	Re-orderable The item may be re-ordered.
199	Receipt advice, fully detailed Includes qualitative and/or quantitative details regarding everything received (all line items) whether or not there were exceptions between what was received and what was advised as being sent.
200	Receipt advice, only exceptions Includes only qualitative and/or quantitative exceptions between what was received and what was advised as being sent.
201	Ingredient is irradiated not applicable The indication that an ingredient of a trade item is irradiated is not applicable.
202	Raw material is irradiated not applicable The indication that raw material of a trade item is irradiated is not applicable.
203	Trade item is genetically modified not applicable The indication that a product has not been genetically modified is not applicable

Used Codes

204	Ingredient is irradiated not applicable The indication that a trade item is irradiated is not applicable.
205	Size dependent pricing An item price may be different depending of the size.
206	Size independent pricing An item price is independent of the size.
207	Only accepted products Includes only details regarding accepted products.
208	Financial compensation Special condition related to a financial compensation.
209	Wrong order Complete order credited due to a wrong order that was previously invoiced.
210	Quality defect Special condition due to quality defect of delivered trade items.
211	Wrong price Special condition related to a previously invoiced incorrect price.
53E	Await further instructions (GS1 Temporary Code) Wait for further instructions as to what to do with the publications. These instructions will either be given in electronic form or by other means such as letter, fax, e-mail.
55E	No action (GS1 Temporary Code) Code indicating the fact that no actions have taken place since the last message.
59E	No pallets (GS1 Temporary Code) Goods are to be supplied without pallets.
61E	Mono item pallet (GS1 Temporary Code) Goods to be supplied on mono item pallet.
69E	Product data publically available (GS1 Temporary Code) A code indicating the fact that the data associated with the current product may be made publically available on a product data base.
70E	Product data not publically available (GS1 Temporary Code) A code indicating the fact that the data associated with the current product may not be made publically available on a product data base.
73E	Delivery subject to final authorization (GS1 Temporary Code) Code indicating the fact that delivery of the order should not take place until final authorization has been received from the delivery party or buyer.
74E	Subject to special rules for hazardous materials (GS1 Temporary Code) A code to indicate that the product is subject to special hazardous materials rules.

Used Codes

75E	Not subject to special rules for hazardous materials (GS1 Temporary Code) A code to indicate that the product is not subject to special hazardous materials rules.
76E	Special conditions applicable to only this invoice (GS1 Temporary Code) This invoice is subject to some special conditions.
77E	Installation order conditions (GS1 Temporary Code) A code indicating order conditions related the installation for the first time, or complete restocking, of the entire range of a retail outlet.
79E	Discrepancies or adjustments (GS1 Temporary Code) Special conditions related to discrepancies or adjustments.
88E	Commodity (GS1 Temporary Code) Company's standard product.
90E	Temporarily out (GS1 Temporary Code) Item is temporarily not available.
91E	Manufacture out (GS1 Temporary Code) Item is out of production.
93E	Seasonally available only (GS1 Temporary Code) Product described is only available in specific seasons or time periods in a year, e.g. christmas decorations.
94E	Deletion, announcement only (GS1 Temporary Code) An announcement to say that the item is in the process of being deleted from the supplier's product range
95E	Temporary product (GS1 Temporary Code) A product which is only available for a temporary period of time.
96E	Product again available (GS1 Temporary Code) A product which was previously unavailable which is once again available.
ACD	Party has access to all non publically available data (GS1 Temporary Code) The identified party has access to all non publically available pricing and non-pricing data associated with the current product.
ACN	Party has access only to non publically available non-pricing data (GS1 Temporary Code) The identified party has access only to the non publically available non-pricing data associated with the current product.
ACP	Party has access only to non publically available pricing data (GS1 Temporary Code) The identified party has access only to the non publically available pricing data associated with the current product.
X1	No back orders when partial delivery (GS1 Temporary Code) Indication that no back orders are allowed when there is a partial delivery.

Used Codes

X10	Include article surveillance (GS1 Temporary Code) Product should contain article surveillance.
X18	Final consumer reservation (GS1 Temporary Code) Goods to be supplied with maximum urgency because final consumer has made reservation (in a retail outlet).
X19	Shelf replenishment merchandise (GS1 Temporary Code) Goods to be placed in a retail outlet shelf.
X2	Back orders accepted when partial delivery (GS1 Temporary Code) Indication that back orders are accepted when there is a partial delivery.
X20	Security stock merchandise (GS1 Temporary Code) Goods to maintain the security stock of a retail outlet.
X44	Item to be included in bonus calculation (GS1 Temporary Code) Item will be included when calculating agreed bonuses.
X5	End consumer promotional item (GS1 Temporary Code) Item is an end consumer promotional item.
X61	Is reload (GS1 Temporary Code) Value indicating the state of the Catalogue Item within the Request for Notification Process being currently on the Notification List.
X62	Is not reload (GS1 Temporary Code) Value indicating the state of the Catalogue Item within the Request for Notification Process being Initial Load.
X8	Provisional (GS1 Temporary Code) Item concerned is provisional.
X9	No empties (GS1 Temporary Code) No empty packaging to exchange, e.g. no empty bottles for ordered drinks.
4347	Product identifier code qualifier Code qualifying the product identifier.
1	Additional identification Information which specifies and qualifies product identifications.
5	Product identification The item number is for product identification.
4441	Free text value code Code specifying free form text.
ACN	Consignment order, no
ACY	Consignment order, yes
AF	Box Number

Used Codes

BI	Barcode information
DUN	Do not record dues (supply only if immediately available)
DUY	Record dues (backorder if not immediately available)
EA	Lable type
HA	Handling information
NE	Customer name
OWN	Do not forward order to publisher
OWY	Forward order to publisher
PKN	Backorder until agreed order volume is reached, no
PKY	Backorder until agreed order volume is reached, yes
PT	Price text
PWN	Batch bonus, no
PWY	Batch bonus, yes
RN	Number of storage rack
RWN	Remittance, no
RWY	Remittance, yes
TUN	Do not supply replacement article
TUY	Automatic supply of replacement article
ZRN	Central settlement, no
ZRY	Central settlement, yes

4451 Text subject code qualifier
Code qualifying the subject of the text.

BAJ Information to be printed on despatch advice
Specification of free text information which is to be printed on a despatch advice.
GS1 Note: Replaces GS1 Temporary Code DSI.

PAC Packing/marketing information
Information regarding the packaging and/or marking of goods.

PUR Purchasing information
Note contains purchasing information.

4453 Free text function code
Code specifying the function of free text.

1 Text for subsequent use
The occurrence of this text does not affect message processing.

Used Codes

5025	Monetary amount type code qualifier Code qualifying the type of monetary amount.
8	Allowance or charge amount [5422] Total amount of allowance or charge.
5125	Price code qualifier Code qualifying a price. Notes: 1. The code set from data element 5387 may also be used as agreed among trading partners.
AAE	Information price, excluding allowances or charges, including taxes The price stated is for information purposes only and excludes all allowances and charges. Taxes however are included in the price.
5245	Percentage type code qualifier Code qualifying the type of percentage.
3	Allowance or charge [5424] Allowance or charge expressed as a percentage.
5387	Price specification code Code identifying pricing specification.
ALT	Alternate price A substitute cost.
LBL	Labelling price Retail price of the buyer that should be printed by the producer on the article's label. The labelling price is not necessary the effective retail price.
5463	Allowance or charge code qualifier Code qualifying an allowance or charge.
A	Allowance Code specifying an allowance. GS1 Description: Deduction in the form of a rate, amount, percentage, or quantity to the price or amount charged for a product.
C	Charge Code specifying a charge. GS1 Description: Addition in the form of a rate, amount, percentage, or quantity to the price or amount charged for a product.

Used Codes

6063	Quantity type code qualifier Code qualifying the type of quantity.
21	Ordered quantity The quantity which has been ordered.
192	Free goods quantity Quantity of goods which are free of charge.
6343	Currency type code qualifier Code qualifying the type of currency.
9	Order currency The name or symbol of the monetary unit used in an order.
10	Pricing currency The name or symbol of the monetary unit used for pricing purposes.
6345	Currency identification code Code specifying a monetary unit.
	Notes: 1. Use ISO 4217 three alpha code.
AED	Dirham
AFN	Afghani
ALL	Lek
AMD	Dram
ANG	Netherlands Antillian Guilder
AOA	Kwanza
ARS	Argentine Peso
AUD	Australian Dollar
AWG	Aruban Florin
AZN	Azerbaijan Manat
BAM	Convertible Mark
BBD	Barbados Dollar
BDT	Taka
BGN	Bulgarian Lev
BHD	Bahraini Dinar
BIF	Burundi Franc
BMD	Bermudian Dollar (customarily: Bermuda Dollar)

Used Codes

BND	Brunei Dollar
BOB	Boliviano
BOV	Mvdol
BRL	Brazilian Real
BSD	Bahamian Dollar
BTN	Ngultrum
BWP	Pula
BYN	Belarussian Ruble
BZD	Belize Dollar
CAD	Canadian Dollar
CDF	Franc Congolais
CHE	WIR Euro
CHF	Swiss Franc
CHW	WIR Franc
CLF	Unidad de Fomento
CLP	Chilean Peso
CNY	Yuan Renminbi
COP	Colombian Peso
COU	Unidad de Valor Real
CRC	Costa Rican Colon
CUC	Peso Convertible
CUP	Cuban Peso
CVE	Cabo Verde Escudo
CZK	Czech Koruna
DJF	Djibouti Franc
DKK	Danish Krone
DOP	Dominican Peso
DZD	Algerian Dinar
EGP	Egyptian Pound
ERN	Nakfa
ETB	Ethopian Birr
EUR	Euro
FJD	Fiji Dollar

Used Codes

FKP	Falkland Islands Pound
GBP	Pound Sterling
GEL	Lari
GHS	Ghana Cedi
GIP	Gibraltar Pound
GMD	Dalasi
GNF	Guinean Franc
GTQ	Quetzal
GYD	Guyana Dollar
HKD	Honk Kong Dollar
HNL	Lempira
HRK	Kuna
HTG	Gourde
HUF	Forint
IDR	Rupiah
ILS	New Israeli Sheqel
INR	Indian Rupee
IQD	Iraqi Dinar
IRR	Iranian Rial
ISK	Iceland Krona
JMD	Jamaican Dollar
JOD	Jordanian Dinar
JPY	Yen
KES	Kenyan Shilling
KGS	Som
KHR	Riel
KMF	Comorian Franc
KPW	North Korean Won
KRW	Won
KWD	Kuwaiti Dinar
KYD	Cayman Islands Dollar
KZT	Tenge
LAK	Lao Kip

Used Codes

LBP	Lebanese Pound
LKR	Sri Lanka Rupee
LRD	Liberian Dollar
LSL	Loti
LYD	Libyan Dinar
MAD	Moroccan Dirham
MDL	Moldovan Leu
MGA	Ariary
MKD	Denar
MMK	Kyat
MNT	Tugrik
MOP	Pataca
MRU	Ouguiya
MUR	Mauritius Rupee
MVR	Rufiyaa
MWK	Malawi Kwacha
MXN	Mexican Peso
MXV	Mexican Unidad de Inversion (UDI)
MYR	Malaysian Ringgit
MZN	Mozambique Metical
NAD	Namibia Dollar
NGN	Naira
NIO	Cordoba Oro
NOK	Norwegian Krone
NPR	Nepalese Rupee
NZD	New Zealand Dollar
OMR	Rial Omani
PAB	Balboa
PEN	Sol
PGK	Kina
PHP	Philippine Piso
PKR	Pakistan Rupee
PLN	Zloty

Used Codes

PYG	Guarani
QAR	Qatari Rial
RON	Romanian Leu This currency code is effective from 1 July 2005
RSD	Serbian Dinar
RUB	Russian Ruble
RWF	Rwanda Franc
SAR	Saudi Riyal
SBD	Solomon Islands Dollar
SCR	Seychelles Rupee
SDG	Sudanese Pound
SEK	Swedish Krona
SGD	Singapore Dollar
SHP	St. Helena Pound
SLL	Leone
SOS	Somali Shilling
SRD	Suriname Dollar
SSP	South Sudanese Pound
STN	Dobra
SVC	El Salvador Colon
SYP	Syrian Pound
SZL	Lilangeni
THB	Baht
TJS	Somoni
TMT	Turkmenistan New Manat
TND	Tunisian Dinar
TOP	Pa'anga
TRY	Turkish Lira
TTD	Trinidad and Tobago Dollar
TWD	New Taiwan Dollar
TZS	Tanzanian Shilling
UAH	Hryvnia
UGX	Uganda Shilling

Used Codes

USD	US Dollar
USN	US Dollar (Next day)
UYI	Uruguayo Peso en Unidades
UYU	Peso Uruguayo
UYW	Unidad Previsional
UZS	Uzbekistan Sum
VES	Bolívar Soberano
VND	Dong
VUV	Vatu
WST	Tala
XAF	CFA Franc
XAG	Silver
XAU	Gold
XBA	Bond Markets Units European Composite Unit (EURCO)
XBB	European Monetary Unit (E.M.U.-6)
XBC	European Unit of Account 9 (E.U.A.-9)
XBD	European Unit of Account 17 (E.U.A.-17)
XCD	East Carribean Dollar
XDR	SDR
XOF	CFA Franc
XPD	Palladium
XPF	CFP Franc
XPT	Platinum
XSU	Sucre
XTS	Codes specifically reserved for testing purposes
XUA	ADB Unit of Account
XXX	The codes assigned for transactions where no currency is involved
YER	Yemeni Rial
ZAR	Rand
ZMW	Zambian Kwacha
ZWL	Zimbabwe Dollar (effective 1 February 2009)

Used Codes

6347	Currency usage code qualifier Code qualifying the usage of a currency.
1	Charge payment currency The currency in which charges are to be paid.
2	Reference currency The currency applicable to amounts stated. It may have to be converted.
3	Target currency The currency which should be used to the target destination of the transaction.
6411	Measurement unit code Code specifying the unit of measurement.
	Notes: 1. Recommend use UN/ECE Recommendation 20, Common code.
001	Barrel (205 litres, 45 gallons) (GS1 Temporary Code) A unit of liquids equivalent to 205 litres or 45 gallons.
23	gram per cubic centimetre GS1 Description: g/cm ³ as a unit of measure for the density of gas. This is necessary for dangerous substance articles for determination of the quantities that can be stored together on the shelf.
25	gram per square centimetre GS1 Description: A measure of weight in terms of gram per square centimetre.
28	kilogram per square metre GS1 Description: Unit of measure expressed in kilogram per square metre.
37	ounce per square foot
59	part per million
64	Pound per square inch, gauge A unit of measure expressed in pound per square inch
2N	decibel
2X	metre per minute GS1 Description: A measure of speed in terms of metres per minute.
4K	milliampere
4L	megabyte GS1 Description: A unit of computer memory equal to 1.048.576 (i.e. 2 power 20) bytes.

Used Codes

40	microfarad GS1 Description: One millionth of a farad. A farad is the capacitance of a capacitor between the plates of which a potential of 1 volt is created by a charge of 1 Coulomb.
4P	newton per metre
A25	cheval vapeur
A86	gigahertz GS1 Description: Hertz multiplied by 10 ⁹ .
A99	Bit A unit of information equal to one binary digit.
ACR	acre GS1 Description: Acre (4840 yd ²)
AD	byte GS1 Description: A unit of information stored in a computer, equal to eight bits.
AMH	ampere hour GS1 Description: Ampere-hour (3,6kC)
AMP	ampere
AMT	amount
ANN	year GS1 Description: The expression of a year as a measure unit.
APZ	Troy ounce or apothecary ounce EDIFACT
ASM	alcoholic strength by mass GS1 Description: Alcoholic strength expressed by mass.
ASU	alcoholic strength by volume GS1 Description: Alcoholic strength expressed by volume.
AV	capsule GS1 Description: Encapsuled dosage form for pharmaceuticals.
B13	Joule per square metre A unit of measure of heat energy expressed in joule per square metre.
B17	Credit A unit of count defining the number of entries made to the credit side of an account.

Used Codes

BAR	bar GS1 Description: A unit of measure equal to 106 dines per square centimeter.
BTU	British thermal unit GS1 Description: British thermal unit (1,055 kilojoules)
C0	call GS1 Description: Unit of measure for telephone calls. Code value is C0 (C Zero).
C60	ohm centimetre GS1 Description: Unit of measure expressed in Ohm centimetre.
C79	Kilovolt Ampere Hour A unit of accumulated energy of 1000 volt amperes over a period of one hour. EDIFACT
CDL	candela GS1 Description: Unit of measure of light intensity.
CEL	degree celsius
CF2	Colony forming unit per gram (GS1 Temporary Code) Colony forming units per gram is a unit of measure for micro-organisms, such as bacteria, in a food item. Micro-organisms form colonies that are be counted under determined conditions
CLT	centilitre GS1 Description: A unit of volume equal to one hundredth of a liter.
CMK	square centimetre
CMQ	cubic centimetre GS1 Description: A system of units for the measurement of volume based on the cubic centimetre.
CMT	centimetre
D19	Square metre kelvin per watt Unit of measure of thermal insulance expressed in square metre kelvin per watt.
D21	square metre per kilogram GS1 Description: Unit of measure expressed in square metre per kilogram.
D32	Terawatt hour A unit of measure expressed in terawatt hour
D5	Kilogram per square centimetre A unit of measure expressed in kilogram per square centimetre

Used Codes

D55	Watt per square metre kelvin Unit of measure of thermal conductance expressed in watt per square metre kelvin.
D68	Number of Words A unit of count defining the number of words. EDIFACT
DAY	day GS1 Description: The expression of a day as a measure unit.
DD	degree GS1 Description: Unit of measure of temperature.
DMQ	cubic decimetre GS1 Description: Unit of measure expressed in cubic decimetre.
DMT	decimetre
DRG	Dragée (GS1 Temporary Code) Number of dragées (coated tablets) contained in the item's package as a measurement unit.
DZN	dozen GS1 Description: A unit of measure of 12 or group of 12.
E09	Milliampere hour A unit of power load delivered at the rate of one thousandth of an ampere over a period of one hour. EDIFACT
E10	Degree day A unit of measure used in meteorology and engineering to measure the demand for heating or cooling over a given period of days. EDIFACT
E11	Gigacalorie A unit of heat energy equal to one thousand million calories. EDIFACT
E27	Dose A unit of count defining the number of doses (dose: a definite quantity of a medicine or drug). EDIFACT
E31	Square metre per litre A unit of count defining the number of square metres per litre. EDIFACT
E32	Litre per hour A unit of count defining the number of litres per hour. EDIFACT

Used Codes

E34	Gigabyte A unit of information equal to 10 E9 bytes.
E37	Pixel A unit of count defining the number of pixels (pixel: picture element).
E38	Megapixel A unit of count equal to 10 E6 (1000000) pixels (picture elements).
E39	Dots per inch A unit of information defining the number of dots per linear inch as a measure of the resolution or sharpness of an image. GS1 Description: synonym: pixels per inch.
EA	each
EV	envelope GS1 Description: A unit of measure pertaining to the number of envelopes.
FAH	degree Fahrenheit
FOT	foot GS1 Description: Foot (0,3048 m)
FP	Pound per square foot A unit of measure expressed in pound per square foot
FTK	Square foot A unit of measure expressed in square foot
FTQ	cubic foot
GL	gram per litre
GLI	gallon (UK) GS1 Description: Gallon (4,546092 dm ³)
GM	gram per square metre GS1 Description: Unit of measure of grams per square metre.
GRM	gram
GRO	gross GS1 Description: A unit of measure of 12 dozens.
GV	gigajoule
GWH	gigawatt hour GS1 Description: Gigawatt-hour (1 million kW/h)

Used Codes

H87	Piece A unit of count defining the number of pieces (piece: a single item, article or exemplar). EDIFACT
HLT	hectolitre
HMT	hectometre A unit of linear measure equal to 10 E2 metres.
HTZ	hertz GS1 Description: One cycle per second.
HUR	hour
INH	inch GS1 Description: Inch (25,4 mm)
INK	Square inch A unit of measure expressed in square inch
JM	Megajoule per cubic metre EDIFACT
JOU	joule
K51	Kilocalorie (mean) EDIFACT
KB	kilocharacter
KBA	kilobar
KEL	kelvin
KGM	kilogram
KHZ	kilohertz
KJO	kilojoule
KL	kilogram per metre GS1 Description: A measure of weight in terms of kilogram per metre.
KMH	kilometre per hour GS1 Description: A unit of measure expressed in kilometre per hour.
KMQ	kilogram per cubic metre GS1 Description: A measure of weight in terms of kilogram per cubic metre.
KMT	kilometre
KPA	kilopascal GS1 Description: Unit of measure expressed in kilopascal.

Used Codes

KVA	kilovolt - ampere GS1 Description: A unit of electric power.
KVT	kilovolt
KWH	kilowatt hour
KWT	kilowatt
L2	litre per minute GS1 Description: Unit of measure expressed in litre per minute.
LBR	Pound EDIFACT
LD	Litre per day A unit of measure defining the number of litres per day.
LNE	Printed line count (GS1 Temporary Code) The indication of the count of printed lines included on a paper communication (e.g. telegram) for invoicing purposes.
LTR	litre GS1 Description: Litre (1 dm ³)
LUX	lux GS1 Description: Unit of measure of illumination (it corresponds to the illumination of a surface which normally and uniformly receives a light flow of 1 lumen per square meter).
M4	Monetary value A unit of measure expressed as a monetary amount. EDIFACT
MAL	mega litre
MAW	megawatt
MC	microgram One millionth of a gram.
MCU	millicurie GS1 Description: Unit of measure for radioactivity.
MGM	milligram
MHZ	megahertz
MIN	minute
MLT	millilitre
MMK	square millimetre GS1 Description: A unit to measure a surface equal to one millionth of a quadrate.

Used Codes

MMQ	cubic millimetre GS1 Description: A unit of measure expressed in cubic milimetres.
MMT	millimetre
MON	month GS1 Description: The expression of a month as a measure unit.
MPA	megapascal GS1 Description: A unit of measure expressed in Megapascal.
MQH	Cubic metre per hour A unit of measure defining the number of cubic metres per hour.
MTK	square metre
MTQ	cubic metre
MTR	metre
MTS	Metre per second A unit of speed expressed in metres per second.
MWH	megawatt hour (1000 kW.h)
NAR	number of articles
NEW	newton GS1 Description: The SI unit of force, equal to the force that would give a mass of one kilogram an acceleration of one metre per second.
NIU	number of international units A unit of count defining the number of international units.
NRL	number of rolls
ONZ	ounce GS1 Description: Ounce GB, US (28,349523 g)
OZA	fluid ounce (US) GS1 Description: Fluid ounce US (29,5735 cm ³)
OZI	fluid ounce (UK) GS1 Description: Fluid ounce UK (28,413 cm ³)
P1	percent GS1 Description: This code is used to indicate measurements in terms of percentages, e.g. the relative humidity (code RA in data element 6313) is 52%.
PA	packet

Used Codes

PAL	pascal GS1 Description: The SI unit of pressure, equal to one Newton per square metre.
PCE	Piece (GS1 Temporary Code) GS1 Note: Old code value. Use value H87 instead.
PF	pallet (lift) GS1 Description: A number of articles expressed in terms of pallets.
PR	pair GS1 Description: Two articles which belong together but are not necessarily identical.
PTI	pint (UK) GS1 Description: Pint UK (0,568262 dm3)
PTN	Portion (GS1 Temporary Code) The identification of the number of portions (doses in medical terms) into which a complete product may be broken into for serving purposes, e.g. a pie with 6 portions, a liquid medicine with 20 doses.
QAN	quarter (of a year)
QTI	quart (UK) GS1 Description: Quart UK (1,1136523 dm3)
RJH	Decanewton (GS1 Temporary Code) A unit of force equal to 10 Newton.
RPM	revolutions per minute
RTO	Ratio (GS1 Temporary Code) The measured value is a ratio.
SEC	second
SMI	Mile (statute mile) A unit of measure expressed in mile
ST	sheet
TNE	tonne (metric ton) GS1 Description: Metric ton (1000kg)
U2	tablet A unit of count defining the number of tablets (tablet: a small flat or compressed solid object). GS1 Description: Dosage form for pharmaceuticals, pressed or compacted from a powder into a solid dose.
UI	Unit of activity, predefined (GS1 Temporary Code) A measure pertaining to a predefined activity.

Used Codes

VI	vial GS1 Description: Small glass container. E.g. for a liquid medicine or perfume.
VLT	volt
WHR	watt hour
WTT	watt
YDK	Square yard A unit of measure expressed in square yard
YRD	yard GS1 Description: Yard (0,9144 m)
ZP	page GS1 Description: The indication of a page as a measurement unit for invoicing purposes, e.g. fax pages.
7143	Item type identification code Coded identification of an item type.
GB	Buyer's internal product group code Product group code used within a buyer's internal systems.
SA	Supplier's article number Number assigned to an article by the supplier of that article.
SRV	GS1 Global Trade Item Number A unique number, up to 14-digits, assigned according to the numbering structure of the GS1 system. 'GS1' stands for the 'Global Standards One'.
7161	Special service description code Code specifying a special service.
0	Released (GS1 Temporary Code) Informs the stockholder it is free to distribute the quality controlled passed goods.
1	Quality control held (GS1 Temporary Code) Instructs the stockholder to withhold distribution of the goods until the manufacturer has completed a quality control assessment.
2	Quality controlled embargo (GS1 Temporary Code) Instructs the stockholder to withhold distribution of goods which have failed quality control tests.
AA	Advertising allowance Description to be provided. GS1 Description: Allowance for the advertising costs or activities related to the product.

Used Codes

AAB	Returned goods charges Self-explanatory. GS1 Description: Charges related to the return of goods.
AAJ	Copper surcharge Difference between current price and basic copper value contained in product price.
AAM	Rubber surcharge Difference between current price and basic value contained in product price.
AAT	Rush delivery Charge for increased delivery speed.
AAX	Wolfram surcharge Difference between current price and basic value contained in product price.
AAZ	Airport fee Charge associated with usage of airport facilities.
ABA	Compulsory storage fee Fee levied to cover the cost of carrying a certain amount of compulsory inventory (set by regulatory agency).
ABH	Throughput allowance Allowance for reaching or exceeding an agreed throughput threshold.
ABL	Packaging surcharge Additional charge for packaging of items.
ABZ	Miscellaneous rebate or discount Non-defined rebate or discount.
ACQ	Royalty surcharge Additional charge on an item's price for royalty.
ACY	Container deposit charge The charge relating to the packaging of a product in a container when the container is expected to be returned and has value when empty.
ACZ	Damaged merchandise The charge or credit relating to the circumstance of product being damaged and not saleable.
ADM	Binding services A code indicating binding services.
ADN	Repair or replacement of broken returnable package The repair or replacement of a broken returnable package.
ADO	Efficient logistics A code indicating efficient logistics services.

Used Codes

ADP	Merchandising A code indicating that merchandising services are in operation.
ADQ	Product mix A code indicating that product mixing services are in operation.
ADR	Other services A code indicating that other non-specific services are in operation.
ADS	Full pallet ordering Ordering of a full pallet of a product.
ADT	Pick-up For the pick-up or collection of goods.
ADZ	Direct delivery The specification of direct delivery as a special service.
AEK	Cash on delivery service An allowance or charge related to the provision of a cash on delivery service.
AEM	Clerical or administrative services The provision of clerical or administrative services.
AEN	Guarantee service The provision of a guarantee service.
AEO	Collection and recycling service The service of collection and recycling products.
AEP	Copyright fee collection services The service of the collection of copyright fees.
AEQ	Charge for exceeding agreed ordered quantity Charge applicable if the ordered quantity exceeds the quantity that has been agreed upon. GS1 Description: Charge when what the buyer is ordering exceeds the quantity that has been agreed upon.
AES	Veterinary inspection service Allowance or charge related to the service of veterinary inspection.
AEV	Environmental protection service An allowance or charge related to a provision of an environmental protection service. GS1 Description: An allowance or charge related to the provision of environmental protection or clean-up services.

Used Codes

AEX	National cheque processing service outside account area Service of processing a national cheque outside the ordering customer's bank trading area. GS1 Description: Service of processing a domestic cheque in an area, outside that where the ordering customer is holding his account.
AEY	National payment service outside account area Service of processing a national payment to a beneficiary holding an account outside the trading area of the ordering customer's bank.
AEZ	National payment service within account area Service of processing a national payment to a beneficiary holding an account within the trading area of the ordering customer's bank.
AG	Silver surcharge Difference between current price and basic value contained in product price.
AJ	Adjustments Description to be provided. GS1 Description: Allowance or charge related to adjustments.
ASS	Assortment allowance (GS1 Temporary Code) Allowance given when a specific part of a suppliers assortment is purchased by the buyer.
CA	Cataloguing services Description to be provided. GS1 Description: Allowance or charge related to the provision of cataloguing services.
CAC	Cash discount Discount incurring with cash payment.
CAG	Competitive allowance Price adjustment allowed for market conditions or factors.
CAI	Cutting charge Description to be provided. GS1 Description: An allowance or charge related to the service of cutting.
CAL	Payroll payment service Provision of a payroll payment service.
CAM	Cash transportation service Provision of a cash transportation service.
CAN	Home banking service Provision of a home banking service.

Used Codes

CAP	<p>Insurance brokerage service Provision of an insurance brokerage service.</p> <p>GS1 Description: Charge or allowance paid to a bank, related to the purchase of insurance using the bank as a broker.</p>
CAQ	<p>Cheque generation service Provision of a cheque generation service.</p> <p>GS1 Description: Charge paid to a bank which relates to the generation of a cheque.</p>
CAR	<p>Preferential merchandising location Service of assigning a preferential location for merchandising.</p>
CAS	<p>Crane service Provision of a crane service.</p>
CAT	<p>Special colour service Providing a colour which is different from the default colour.</p>
CAU	<p>Sorting The provision of sorting services. EDIFACT</p>
CAV	<p>Battery collection and recycling The service of collection and recycling batteries.</p>
CAW	<p>Product Take Back Fee The fee the consumer must pay the manufacturer to take back the product.</p>
CP	<p>Competitive price Description to be provided.</p> <p>GS1 Description: Allowance or charge related to the availability of a competitive price.</p>
DAE	<p>Distributor discount/allowance Specific discount/allowance for distributors.</p>
DBD	<p>Debtor bound (GS1 Temporary Code) A special allowance or charge applicable to a specific debtor.</p>
DDA	<p>Dealer discount/allowance (GS1 Temporary Code) A discount or allowance offered by a party dealing a certain brand or brands of products.</p>
DI	<p>Discount A reduction from a usual or list price.</p> <p>GS1 Description: A discount is a reduction in the price of an item offered on a one off basis. An important distinction to make between discount and an allowance offered is that an allowance is a reduction which is offered on a regular basis.</p>

Used Codes

DTC	Discount transferable to the consumer (GS1 Temporary Code) A discount given by the manufacturer which should be transferred to the consumer.
EAA	Early buy allowance Allowance granted to customers buying early.
EAB	Early payment allowance Allowance granted to customers paying early.
FA	Freight allowance Description to be provided. GS1 Description: Allowance for the shipment of goods or commodity.
FC	Freight charge Amount to be paid for moving goods, by whatever means, from one place to another, inclusive discounts, allowances, rebates, adjustment factors and additional cost relating to freight costs (UN/ECE Recommendation no 23).
FG	Free goods Allowance or rebate granted by delivery of goods free of charge.
FI	Finance charge Description to be provided. GS1 Description: A charge related to the provision of financing.
FR	Flat Rate (GS1 Temporary Code) A flat rate is applied.
GRB	Growth of business (GS1 Temporary Code) An allowance or charge related to the growth of business over a pre-determined period of time.
HD	Handling Charge for handling of the item.
IN	Insurance Charge for insurance.
INT	Introduction allowance (GS1 Temporary Code) An allowance related to the introduction of a new product to the range of products traded by a retailer.
IS	Invoice services Description to be provided. GS1 Description: An allowance or charge related to the provision of invoicing services.
LA	Labelling Service of labelling items.

Used Codes

MAC	Minimum order/minimum billing charge Description to be provided.
MB	Multi-buy promotion (GS1 Temporary Code) A code indicating special conditions related to a multi-buy promotion.
MC	Material surcharge (special materials) Description to be provided. GS1 Description: A surcharge related to the use of special materials.
NAA	Non-returnable containers Description to be provided. GS1 Description: An allowance or charge related to the use of non-returnable containers.
PAD	Promotional allowance Description to be provided. GS1 Description: An allowance related to a promotion.
PAE	Promotional discount Description to be provided. GS1 Description: A discount related to a promotion.
PAR	Partnership allowance (GS1 Temporary Code) An allowance or charge related to the establishment and on-going maintenance of a partnership.
PC	Packing Charge for packing.
PI	Pick-up allowance Description to be provided. GS1 Description: An allowance related to the pick up of goods.
PL	Palletizing Description to be provided. GS1 Description: An allowance or charge related to the palletization of goods.
PN	Pallet charge Description to be provided. GS1 Description: A charge related to the use of pallets.
QAA	Quantity surcharge Fee associated with providing goods outside "normal" quantity limits. GS1 Description: Fee associated with providing goods outside "normal" quantity limits.

Used Codes

QD	Quantity discount Description to be provided. GS1 Description: A discount related to the purchase of a specified quantity.
RAA	Rebate Description to be provided. GS1 Description: A rebate is the refund of part of an amount already paid for a product or service.
RAD	Returnable container Description to be provided. GS1 Description: An allowance or charge related to the use of returnable containers.
RAE	Resellers discount Description to be provided.
RCH	Return handling (GS1 Temporary Code) An allowance or charge related to the handling of returns.
SER	Service charge (GS1 Temporary Code) A charge related to the provision of a guarantee.
SH	Special handling service Description to be provided. GS1 Description: An allowance or charge related to the provision of special handling services.
TAE	Truckload discount Description to be provided. GS1 Description: A discount associated with the purchase or delivery of full trucks of a product or products.
TD	Trade discount Description to be provided. GS1 Description: A standard trade discount.
TX	Tax Contribution levied by an authority.
TZ	Temporary allowance Description to be provided. GS1 Description: An allowance which is available on a temporary basis.
VAB	Volume discount Discount offered based on the amount of purchase.
WHE	Wholesaling discount (GS1 Temporary Code) A special discount related to the purchase of products through a wholesaler.

Used Codes

X01	Allowance Global (GS1 Temporary Code) A global allowance is applied.
X02	Charge Global (GS1 Temporary Code) A global charge is applied.
X03	Consolidated (GS1 Temporary Code) A charge is consolidated.
X04	Lump sum (GS1 Temporary Code) A lump sum charge applied.
X05	Markup for small volume purchases (GS1 Temporary Code) A mark up is applied for small volume purchases.
X21	Special agreement (GS1 Temporary Code) Charge or allowance which relates to a special agreement.
X22	Bank charges information (GS1 Temporary Code) Charges not included in the total charge amount.
X23	Transfer commission (GS1 Temporary Code) Fee for the transfer of transferable documentary credits.
X29	Mimumum order not fulfilled charge (GS1 Temporary Code) Charge levied because the minimum order quantity could not be fulfilled.
X30	Point of sales allowance (GS1 Temporary Code) Allowance for reaching or exceeding an agreed sales threshold at the point of sales.
X31	Remittance (GS1 Temporary Code) Charge or allowance related to the service of a payment carried out with a cheque from a city different to the city where the beneficiary has the account.
X32	National consignment (GS1 Temporary Code) Charge or allowance which relates to the service of a payment carried out outside the city where the account was opened.
X33	Local consignment (GS1 Temporary Code) Charge or allowance which relates to the service of a payment carried out within the city where the account was opened.
X40	Allowance/charge regulated by law (GS1 Temporary Code) An allowance/charge related to a regulatory requirement.
XAA	Combine all same day shipment Description to be provided. GS1 Description: An allowance or charge related to the combination of all same day shipments.
8051	Transport stage code qualifier Code qualifying a specific stage of transport.

Used Codes

1	Inland transport Transport by which goods are moved from or to the frontier, or between inland points.
10	Pre-carriage transport Transport by which the goods are moved prior to their main carriage transport.
11	At border Transport by which goods are moved to the Customs frontier.
12	At departure Transport by which goods are moved from the place of departure.
13	At destination Transport by which goods are moved at the place of destination.
20	Main-carriage transport The primary stage in the movement of cargo from the point of origin to the intended destination.
25	Delivery carrier all transport Carrier responsible from the point of origin to the final delivery destination.
30	On-carriage transport Transport by which the goods are moved after the main carriage transport.
I	Origin switch carrier (GS1 Temporary Code) Carrier taking responsibility for the goods from the carrier which has transported them from their point of origin.

8179

Transport means description code
Code specifying the means of transport.

1	Barge chemical tanker A barge equipped to transport liquid chemicals.
9	Exceptional transport Transport for which common characteristics are not applicable (e.g. big transformers requiring special wagons, special tackles, special routing etc.).
12	Ship tanker A large vessel equipped to transport liquids.
13	Ocean vessel
19	Tip-up truck A truck capable of tipping up in order to deliver its load.
20	Furniture truck A truck used explicitly for the conveyance of furniture.
21	Rail tanker A rail wagon equipped to transport liquids.

Used Codes

22	Rail silo tanker Self explanatory. Notes: This code value will be removed effective with directory D.04B.
23	Rail bulk car A rail wagon equipped to transport bulk cargo.
26	Tip-up articulated truck An articulated truck capable of tipping up in order to deliver its load.
28	Refrigerated truck and trailer A combined truck and trailer equipped to maintain refrigerated temperatures. GS1 Description: A truck and trailer capable of transporting refrigerated goods.
29	Freezer truck and trailer A combined truck and trailer equipped to maintain freezing temperatures. GS1 Description: A truck and trailer capable of transporting frozen goods.
30	Tautliner 25 tonne, combined with 90 cubic meter trailer with removable roof A truck with non-ridged sides, 25 tonne capacity combined with a 90 cubic meter trailer with removable roof.
31	Truck An automotive vehicle for hauling goods.
32	Road tanker An over-the-road tank trucker or trailer.
35	Truck/trailer with tilt A truck and trailer combination with a tilting capability. GS1 Description: A truck/trailer fitted with a tilting mechanism.
40	Truck with opening floor A truck with an opening floor mechanism which is used to discharge the cargo.
41	Freezer truck A truck equipped to maintain freezing temperatures.
42	Isothermic truck A truck equipped to maintain controlled temperatures.
43	Refrigerated truck A truck equipped to maintain refrigerated temperatures. GS1 Description: A truck capable of transporting refrigerated goods.

Used Codes

44	Freezer van A small rigid covered vehicle for conveying frozen goods. GS1 Description: A van capable of transporting frozen goods.
45	Isothermic van A small rigid covered vehicle for conveying temperature controlled goods. GS1 Description: A van capable of transporting temperature controlled goods.
46	Refrigerated van A small rigid covered vehicle for conveying refrigerated goods. GS1 Description: A van capable of transporting refrigerated goods.
47	Bulk truck A truck suitable for transporting bulk goods.
48	Van A small vehicle suitable for carrying small volume loads.
73	Train with more than one and less than 20 wagons A train with more than one and less than 20 wagons used to carry goods.
74	Train with 20 or more wagons A train with 20 or more wagons used to carry goods.
77	Freezer truck and isothermic trailer A combined freezer truck and isothermic trailer.
78	Isothermic truck and isothermic trailer A truck and a trailer equipped to maintain controlled temperatures.
79	Refrigerated truck and isothermic trailer A combined refrigerated truck and isothermic trailer.
80	Freezer truck and refrigerated trailer A combined freezer truck and refrigerated trailer.
81	Isothermic truck and refrigerated trailer A combined isothermic truck and refrigerated trailer.
82	Rigid truck with tank and tank trailer A combined rigid truck with tank and tank trailer.
83	Bulk truck and tank trailer A combined truck capable of carrying liquids or bulk goods and a tank trailer.
84	Rigid truck with tank and bulk trailer A combined rigid truck with tank and a trailer capable of carrying liquids or bulk goods.
85	Bulk truck and bulk trailer A combined truck and a trailer both capable of carrying liquids or bulk goods.

Used Codes

86	Tautliner truck and extendable trailer A combined tautliner truck and extendable trailer.
87	Tautliner truck with removable roof and extendable trailer A combined tautliner truck with removable roof and extendable trailer.
88	Truck with opening floor and extendable trailer A combined truck with opening floor and extendable trailer.
89	Bulk truck and extendable trailer A combined truck capable of carrying liquids or bulk goods and an extendable trailer.
90	Isothermic truck and freezer trailer A combined isothermic truck and freezer trailer.
91	Refrigerated truck and freezer trailer A combined refrigerated truck and freezer trailer.
92	Tip-up truck and gondola trailer A combined tip-up truck and gondola trailer. A gondola trailer is a split level trailer suitable for the transport of heavy machinery.
93	Tautliner truck and gondola trailer A combined tautliner truck and gondola trailer. A gondola trailer is a split level trailer suitable for the transport of heavy machinery.
94	Tautliner truck with removable roof and gondola trailer A combined tautliner truck with removable roof and gondola trailer. A gondola trailer is a split level trailer suitable for the transport of heavy machinery.
95	Truck with opening floor and gondola trailer A combined truck with opening floor and gondola trailer. A gondola trailer is a split level trailer suitable for the transport of heavy machinery.
96	Bulk truck and gondola trailer A combined truck capable of carrying liquids or bulk goods and a gondola trailer. A gondola trailer is a split level trailer suitable for the transport of heavy machinery.
97	Tip-up truck and extendable gondola trailer A combined tip-up truck with extendable gondola trailer. An extendable gondola trailer is a trailer fitted with a rear axle which can be extended to cater for variable length and is suitable for the transport of heavy machinery.
98	Tautliner truck and extendable gondola trailer A combined tautliner truck and extendable gondola trailer. An extendable gondola trailer is a trailer fitted with a rear axle which can be extended to cater for variable length and is suitable for the transport of heavy machinery.

Used Codes

99	Tautliner truck with removable roof and extendable gondola trailer A combined tautliner truck with removable roof and extendable gondola trailer. An extendable gondola trailer is a trailer fitted with a rear axle which can be extended to cater for variable length and is suitable for the transport of heavy machinery.
100	Truck with opening floor and extendable gondola trailer A combined truck with opening floor and extendable gondola trailer. An extendable gondola trailer is a trailer fitted with a rear axle which can be extended to cater for variable length and is suitable for the transport of heavy machinery.
101	Bulk truck and extendable gondola trailer A combined truck capable of carrying liquids or bulk goods and a extendable gondola trailer. An extendable gondola trailer is a trailer fitted with a rear axle which can be extended to cater for variable length and is suitable for the transport of heavy machinery.
102	Tip-up truck and trailer with opening floor A combined tip-up truck and trailer with opening floor.
103	Tautliner truck and trailer with opening floor A combined tautliner truck and trailer with opening floor.
104	Tautliner truck with removable roof and trailer with opening floor A combined tautliner truck with removable roof and trailer with opening floor.
106	Bulk truck and trailer with opening floor A combined truck capable of carrying liquids or bulk goods and a trailer with opening floor.
3138	Armoured vehicle Automotive vehicle designed with fortified body for enhanced protection.
10E	Tautliner 25t (GS1 Temporary Code) A 25t Tautliner truck/trailer.
11E	Tautliner 25t with removable roof (GS1 Temporary Code) A 25t Tautliner truck/trailer with removable roof.
12E	Articulated flat lorry 25t (GS1 Temporary Code) An articulated flat lorry capable of carrying loads of 25 tonnes.
13E	Articulated flat lorry 24t with crane 10m (GS1 Temporary Code) An articulated flat lorry with a 10 meter crane capable of carrying loads of 24 tonnes.
14E	Articulated flat lorry 24t with crane 15m (GS1 Temporary Code) An articulated flat lorry with a 15 meter crane capable of carrying loads of 24 tonnes.
15E	Articulated flat lorry 24t with crane 18m (GS1 Temporary Code) An articulated flat lorry with a 18 meter crane capable of carrying loads of 24 tonnes.

Used Codes

16E	Articulated flat lorry 10t (GS1 Temporary Code) An articulated flat lorry capable of carrying loads of 10 tonnes.
17E	Tautliner 25t with trailer 90m3 (GS1 Temporary Code) A 25t Tautliner truck/trailer with a 90 m3 trailer.
18E	Tautliner 25t with trailer 120m3 (GS1 Temporary Code) A 25t Tautliner truck/trailer with a 120 m3 trailer.
19E	Flat lorry with trailer and crane 10m (GS1 Temporary Code) An flat lorry with a trailer and a 10 meter crane.
20E	Articulated lorry with tank (GS1 Temporary Code) An articulated lorry fitted with a tank capable of carrying liquids or bulk goods..
21E	Flat lorry 15t (GS1 Temporary Code) A flat lorry capable of carrying loads of 15 tonnes.
22E	Flat lorry 25t with crane (GS1 Temporary Code) An flat lorry fitted with a crane and capable of carrying loads of 25 tonnes.
27E	Isothermic trailer (GS1 Temporary Code) A trailer capable of transporting temperature controlled goods.
28E	Refrigerated trailer (GS1 Temporary Code) A trailer capable of transporting refrigerated goods.
32E	Trailer (GS1 Temporary Code) A trailer suitable for transporting containerised or palletized goods.
33E	Tank trailer (GS1 Temporary Code) A tank trailer suitable for transporting liquids.
34E	Bulk trailer (GS1 Temporary Code) A trailer suitable for transporting bulk goods.
37E	Extendable trailer (GS1 Temporary Code) A trailer fitted with a rear axle which can be extended to cater for variable length loads.
38E	Dolly trailer (GS1 Temporary Code) A trailer composed of a platform mounted on an axle. The trailer is not connected directly to the truck but connected by the load.
39E	Freezer trailer (GS1 Temporary Code) A trailer suitable for transporting frozen goods.
41E	Furniture removal trailer (GS1 Temporary Code) A trailer used explicitly for the removal of furniture.
44E	Gondola trailer (GS1 Temporary Code) A split level trailer suitable for the transport of heavy machinery (e.g. earth movers).

Used Codes

45E	Extendable gondola trailer (GS1 Temporary Code) A trailer fitted with a rear axle which can be extended to cater for variable length loads and is suitable for the transport of heavy machinery (e.g. earth movers).
46E	Rigid lorry with tank (GS1 Temporary Code) A rigid lorry fitted with a tank capable of carrying liquids or bulk goods.
50E	Tautliner rigid truck (GS1 Temporary Code) A Tautliner rigid truck.
51E	Tautliner rigid truck with removable roof (GS1 Temporary Code) A Tautliner rigid truck with removable roof.
53E	Trailer with opening floor (GS1 Temporary Code) A trailer with an opening floor mechanism which is used to discharge the cargo.
54E	Train with convergent set of wagons (GS1 Temporary Code) A train with wagons coming from different despatch locations which must be grouped in order to form one train.
55E	Train with divergent set of wagons (GS1 Temporary Code) A train with wagons coming from the same despatch location which will be split in different trains because there are more than one point of delivery.
56E	Combination of a truck (length 6 m) and a trailer (length 8 m) (GS1 Temporary Code) Combination of a truck (length 6 m) and a trailer (length 8m) having a combined tonnage of between 23 and 25 tons and a loading capacity of 90m ³ .
57E	Combination of a truck (length 6 m) and a trailer (length 9 m) (GS1 Temporary Code) Combination of a truck (length 6m) and a trailer (length 9m) having a combined tonnage of between 23 and 25 tons and a loading capacity of 100m ³ .
58E	Combination of a truck and trailer with a length of 13.6m, a tonnage between 23 and 25 tons (GS1 Temporary Code) Combination of a truck and a trailer with a length of 13.6m, a tonnage between 23 and 25 tons, and a loading capacity of 80 m ³ .
59E	Rail wagon (GS1 Temporary Code) A single rail wagon used to carry goods.
77E	Furniture truck and trailer (GS1 Temporary Code) A combined truck and trailer capable of carrying furniture.
78E	Tautliner truck and furniture trailer (GS1 Temporary Code) A combined tautliner truck and furniture trailer.
79E	Tautliner truck with removable roof and furniture trailer (GS1 Temporary Code) A combined tautliner truck with removable roof and furniture trailer.

Used Codes

93E	Truck and trailer with opening floor (GS1 Temporary Code) A combined truck and a trailer with an opening floor.
95E	Tautliner truck and dolly trailer (GS1 Temporary Code) A combined tautliner truck and a dolly trailer.
96E	A tautliner truck with removable roof and a dolly trailer (GS1 Temporary Code) A combined tautliner truck with removable roof and a dolly trailer.
97E	Truck with trailer (GS1 Temporary Code) Combined truck and trailer.
98E	Truck with crane for moving goods without trailer (GS1 Temporary Code) A truck with a crane that enables to move goods, without trailer.
99E	Truck with crane for moving goods with trailer (GS1 Temporary Code) A truck with a crane that enables to move goods, with trailer.
X01	Truck with crane for lifting goods without trailer (GS1 Temporary Code) A truck with a crane that enables to lift goods, without trailer.
X02	Truck with crane for lifting goods with trailer (GS1 Temporary Code) A truck with a crane that enables to lift goods, with trailer.
X04	Courier express (GS1 Temporary Code) Use the fastest courier means possible.
X05	Road parcel express (GS1 Temporary Code) Parcel express service by road.
X06	Air freight (GS1 Temporary Code) Air freight delivery service.
X07	Surface air lifting (GS1 Temporary Code) Surface air lifting postal service.
X08	Air express (GS1 Temporary Code) Air express delivery service.
X09	Parcel post (GS1 Temporary Code) Postal service for the delivery of parcels.
X10	Mail express (GS1 Temporary Code) The express mail service of the postal service.
X11	Surface mail (GS1 Temporary Code) For non air mail international mailing.
X12	Accelerated surface mail (GS1 Temporary Code) Higher priority surface mail.
X13	Air mail (GS1 Temporary Code) Use air mail service.

Used Codes

X14	Printed matter/book post (GS1 Temporary Code) A special mailing service for printed matter or books.
X15	Parcel delivery registered (GS1 Temporary Code) Service for the delivery of registered parcels
X16	Parcel delivery express service registered (GS1 Temporary Code) Express service for the delivery of registered parcels
X3	Truck up to 3,5 tons (GS1 Temporary Code) A truck with a total weight up to 3,5 tons.
X4	Miscellaneous transport means (GS1 Temporary Code) Miscellaneous means of transport not further defined.

Example**UNA:+. ? '**

The UNA segment contains the default service string characters.

UNB+UNOC:3+4012345000009:14:4012345000018+4000004000002:14:4000004000099+181013:1043+4711+REF:AA++++EANCOM+1 '

The EANCOM file 4711 dated 13.10.2018, 10 h 43 is sent by the issuer identified with GLN 4012345000009 to the receiver identified with GLN 4000004000002.

UNH+ME0001+ORDERS:D:01B:UN:EAN011 '

The reference number of the ORDERS message is ME0001.

BGM+220:::X+128576+9 '

The document number is 128576.

DTM+137:20181020:102 '

Date of the order confirmation is the 20th of October 2018.

DTM+2:20181028:102 '

Requested delivery date is the 28th of October 2018.

DTM+61:201810230800:203 '

The example request the cancellation if not delivered until the 23th of October 2018 at 8.00 a.m.

ALI+++X2 '

Partial order allowed

FTX+PUR++DUN:MEDIA:246 '

Do not record dues.

RFF+CT:4711 '

The order is based on order reference no. 4711.

RFF+SS:4711 '

The order is based on sellers reference no. 4711.

RFF+PD:4711 '

The order is based on promotion deal no. 4711.

RFF+ECN:15687 '

The order is based on the collective order number 15687.

NAD+SU+4012345000009::9+X:X:X:X:X '

The supplier/manufacturer is identified by Global Location Number (GLN) 4012345000009.

NAD+BY+4398765000004::9+X:X:X:X:X '

The order is generated by a buyer with the Global Location Number (GLN) 4398765000004.

RFF+YC1:22369 '

The additional party identification (customer) is 22369.

NAD+IV+4012345000009::9 '

The invoicee is identified by Global Location Number (GLN) 4012345000009.

NAD+DP+4399899175941::9++EDI-LAND:Herr Laufen:Garage+Bussardweg 5+Leopardshöhle++33818+DE '

The receiver is identified by Global Location Number (GLN) 4399899175941. An address in clear text is only allowed in exceptional cases.

NAD+UC+4399899175941::9++EDI-LAND:Herr Laufen:Garage+Bussardweg 5+Leopardshöhle++33818+DE '

Example

The ultimate consignee is identified by Global Location Number (GLN) 4399899175941. An address in clear text is only allowed in exceptional cases.

CUX+2:EUR:9'

Order Currency is EURO

TDT+20+++31+4012345123456::9:Transport GmbH Schnelle Bücher'

road parcel express: "Transport GmbH Schnelle Bücher"

LIN+3++4000004000033:SRV'

The ordered item with the item number 3 is identified by GTIN 4000004000035.

PIA+5+ABC5343:SA::91'

Only if LIN does not provide a GTIN: Item identification in PIA

PIA+1+4711:GB::92'

The article belongs to the class of goods "4711"

QTY+21:20'

The ordered quantity amounts to 20 pieces of the article no. described in the LIN segment. (GTIN).

QTY+192:20'

The free quantity amounts to 20 pieces of the article no. described in the LIN segment. (GTIN).

ALI+++X2'

Partial order allowed

DTM+2:20181028:102'

This example requires the delivery on 28th of October 2018.

DTM+61:201810230800:203'

The example request the cancellation if not delivered until 23th of October 2018 at 8.00 a.m.

FTX+PUR++DUN:MEDIA:246'

Do not record dues.

FTX+BAJ+1+NE:MEDIA:246+Max Mustermann+DE'

Name of customer: Max Mustermann

FTX+PAC+1++4012345123456'

The GTIN 13 barcode "4012345123456" should printed on the lable.

PRI+AAE:19.98::LBL:1:H87'

The labeling price per piece is 19.98 EURO incl. tax.

PRI+AAE:10.61::ALT:1:H87'

The labeling price per piece is 10.61 US\$ incl. tax

CUX+2:CHF:10'

Specification of the labeling price currency

RFF+CR:4711'

The order reference is 4711.

RFF+SS:4711'

The order is based on sellers reference no. 4711.

RFF+PD:4711'

The order line is based on promotion deal no. 4711.

RFF+LI:4711'

Example

The order line is based on line item reference 4711.

RFF+SD:4711'

The order line is for department 4711.

ALC+A++++DI'

Condition for information: Allowance

PCD+3:5'

5 percent

MOA+8:2.99'

equals 2,99 EURO

UNS+S'

Separation between detail and summary section

UNT+182+ME0001'

Number of segments in the message.

UNZ+1+4711'

The transmission file contains 1 message.
